

4000 Series 4012-46TWG2A Diesel Engine – Electropak

Non-Emissions compliant

1166 kWm 1500 rpm

1166 kWm 1800 rpm

The new 4012-46TWG engine has been developed using the latest engineering techniques and builds on the strengths of the already very successful 4012 Series family and addresses today's uncompromising demands within the power generation industry. Developed from a proven heavy-duty industrial base these products offer superior performance and reliability.

The 4012-46TWG2A is a turbocharged and air-to-water charge-cooled, 12 cylinder diesel engine which offers a choice of temperate or tropical cooling. Its premium features provide exceptional power-to-weight ratio resulting in exceptional fuel consumption.

The overall performance and reliability characteristics makes this one of the prime choices for today's power generation industry.

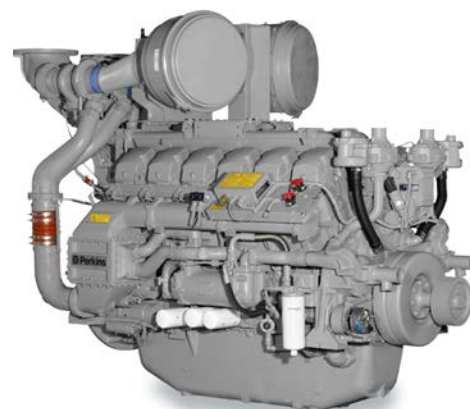

Economic power

- Individual 4 valve per cylinder give optimised gas flows, while unit fuel injectors ensure ultra fine fuel atomisation and hence controlled rapid combustion for efficiency and economy
- Commonality of components with other engines in the 4000 Series family allows reduced parts stocking levels for the end users

Reliable power

- Developed and tested using latest engineering techniques
- Piston temperatures are controlled by an advanced gallery jet cooling system
- All engines are tolerant of a wide range of temperatures without derate
- Service is provided through the extensive Perkins network of distributors and dealers worldwide

Clean, efficient power

- Exceptional power to weight ratio and compact size for easier transportation and installation
- Designed to provide excellent service access for ease of maintenance

- Engines designed to comply with major international standards
- Low gaseous emissions for cleaner operation

Product support

- Perkins actively pursues product support excellence by ensuring our distribution network invest in their territory – strengthening relationships and providing more value to you, our customer
- Through an experienced global network of distributors and dealers, fully trained engine experts deliver total service support around the clock, 365 days a year. They have a comprehensive suite of web based tools at their fingertips covering technical information, parts identification and ordering systems, all dedicated to maximising the productivity of your engine
- Throughout the entire life of a Perkins engine, we provide access to genuine OE specification parts and service. We give 100% reassurance that you receive the very best in terms of quality for lowest possible cost .. wherever your Perkins powered machine is operating in the world

This engine does not comply with harmonized international regulated emissions limits.

Engine Speed (rev/min)	Type of Operation	Typical Generator Output (Net)		Engine Power			
				Gross		Net	
		kVA	kWe	kWm	bhp	kWm	bhp
1500	Baseload Power	989	791	891	1194	833	1117
	Prime Power	1250	1000	1113	1492	1055	1414
	Standby (maximum)	1385	1108	1224	1641	1166	1563
1800	Baseload Power	989	791	891	1194	833	1117
	Prime Power	1250	1000	1113	1492	1055	1414
	Standby (maximum)	1375	1100	1224	1641	1166	1563

The above ratings represent the engine performance capabilities guaranteed within plus or minus 3% at the reference conditions equivalent to those specified in ISO 8528/1, ISO 3046/1, BS 5514/1.

Rating conditions: 25°C air inlet temperature, barometric pressure 100 kPa, relative humidity 30%. Please consult your distributor or the factory for ratings in other ambient conditions. *Note: For full ratings please refer to Perkins Engines Company Limited. All electrical ratings are based on an average alternator efficiency and a power factor of 0.8. Fuel specification: BS2869: Class A2.*

Rating Definitions

Baseload Power: Power available for continuous full load operation. No overload is permitted. **Prime Power:** Power available for variable load with an average load factor not exceeding 80% of the prime power rating in any 24 hour period. Overload of 10% permitted for 1 hour in every 12 hours operation. **Standby (maximum):** Power available at variable load in the event of a main power network failure up to a maximum of 500 hours per year. No overload is permitted.

Photographs are for illustrative purposes only and may not reflect final specification.

All information in this document is substantially correct at time of printing and may be altered subsequently.
Publication No. PN1853/10/13 Produced in England ©2013 Perkins Engines Company Limited

 **Perkins**[®]

THE HEART OF EVERY GREAT MACHINE

4000 Series 4012-46TWG2A Diesel Engine – ElectropaK Non-Emissions compliant

1166 kWm 1500 rpm

1166 kWm 1800 rpm

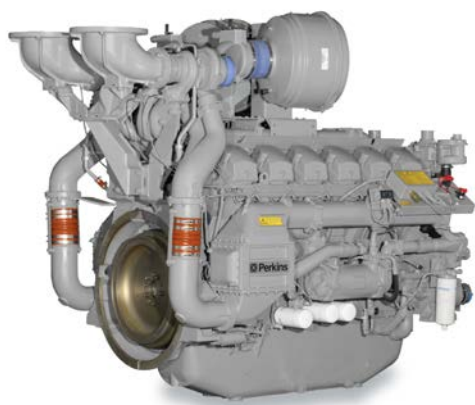

Standard ElectropaK specification

Air inlet

- Mounted air filters and turbochargers

Fuel system

- Direct fuel injection system with fuel lift pump
- Governing to ISO 8528-5 class G3 with isochronous capability
- Full-flow spin-on fuel oil filters

Lubrication system

- Wet sump with filler and dipstick
- Full-flow spin-on oil filters
- Engine jacket water/lub oil temperature stabiliser

Cooling system

- Two twin thermostats
- System designed for ambients up to 50°C
- Powder coated radiator comprising: water radiator; fuel oil cooling (optional); all pipes, hoses and clips; fan; pulleys; fan belts and safety guards

Electrical equipment

- 24 volt starter motor and 24 volt alternator with integral regulator and DC output
- Overspeed switch and magnetic pickup
- Turbine inlet temperature shutdown switch
- Twin high coolant temperature shutdown switches
- Twin low oil pressure shutdown switches

Flywheel and housing

- Flywheel to SAE J620 size 18
- SAE 00 flywheel housing

Optional equipment

Choice of temperate or tropical radiators available dependant on operational cooling requirements

Fuel oil cooler integral to the radiator assembly

Immersion heater with thermostat

Note: This list is not exhaustive, further options will be available at the product's introduction

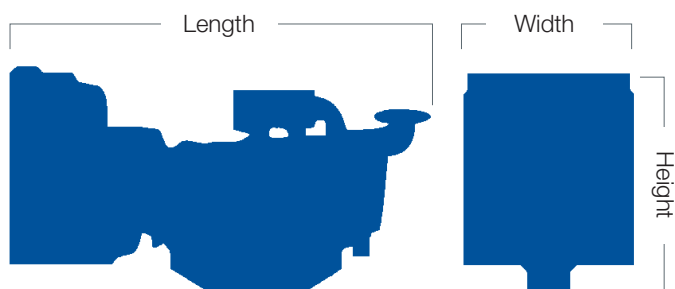

See 'General data – Dimensions' below

Engine Speed	Fuel Consumption			
	1500 rev/min		1800 rev/min	
	g/kWh	l/hr	g/kWh	l/hr
Standby	213	288	220	298
Prime Power	212	259	217	266
Continuous Baseload	214	207	216	209
75% of Prime Power	216	196	tbc	tbc
50% of Prime Power	233	143	tbc	tbc

General data

Number of cylinders	12		
Cylinder arrangement	60° Vee form		
Bore and stroke.....	160 x 190 mm		
Displacement	45.842 litres		
Induction system	Turbocharged and air to water charge cooled		
Cycle.....	4 stroke		
Combustion system.....	Direct injection		
Compression ratio	13.6:1		
Rotation.....	Anti-clockwise, viewed from flywheel end		
Cooling system.....	Water-cooled		
Firing order	1A, 6B, 5A, 2B, 3A, 4B, 6A, 1B, 2A, 5B, 4A, 3B		
Total lubrication system capacity.....	177 litres		
	Temperate	Tropical	
Total coolant capacity	196 litres	201 litres	
Total weight (dry).....	5220 kg	5283 kg	
Dimensions – Length	3714 mm	3714 mm	
Width	1780 mm	1978 mm	
Height	2255 mm	2255 mm	

Final weight and dimensions will depend on completed specification

Photographs are for illustrative purposes only and may not reflect final specification.

All information in this document is substantially correct at time of printing and may be altered subsequently.
Publication No. PN1853/10/13 Produced in England
©2013 Perkins Engines Company Limited

Perkins Engines Company Limited

Peterborough PE1 5FQ

United Kingdom

Telephone +44 (0)1733 583000

Fax +44 (0)1733 582240

www.perkins.com



THE HEART OF EVERY GREAT MACHINE

PI734A - Technical Data Sheet

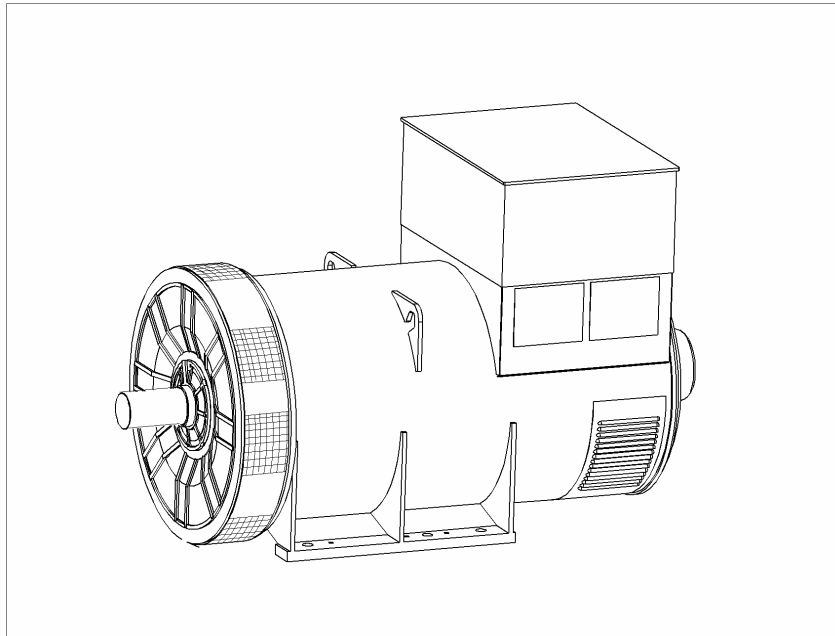

PI734A

SPECIFICATIONS & OPTIONS



STANDARDS

Newage Stamford industrial generators meet the requirements of BS EN 60034 and the relevant sections of other national and international standards such as BS5000, VDE 0530, NEMA MG1-32, IEC60034, CSA C22.2-100, AS1359.

Other standards and certifications can be considered on request.

DESCRIPTION

The STAMFORD PI range of synchronous ac generators are brushless with a rotating field. They are separately excited by the STAMFORD Permanent Magnet Generator (PMG). This is a shaft mounted, high frequency, pilot exciter which provides a constant supply of clean power via the Automatic Voltage Regulator (AVR) to the main exciter. The main exciter output is fed to the main rotor, through a full wave bridge rectifier, protected by surge suppression.

VOLTAGE REGULATORS

The PI range generators complete with a PMG are available with one of two AVRs. Each AVR has soft start voltage build up and built in protection against sustained over-excitation, which will de-excite the generator after a minimum of 8 seconds.

Underspeed protection (UFRO) is also provided on both AVRs. The UFRO will reduce the generator output voltage proportional to the speed of the generator below a pre-settable level.

The **MX341 AVR** is two phase sensed with a voltage regulation of $\pm 1\%$. (see the note on regulation).

The **MX321 AVR** is 3 phase rms sensed with a voltage regulation of 0.5% rms (see the note on regulation). The UFRO circuit has adjustable slope and dwell for controlled recovery from step loads. An over voltage protection circuit will shutdown the output device of the AVR, it can also trip an optional excitation circuit breaker if required. As an option, short circuit current limiting is available with the addition of current transformers.

Both the MX341 and the MX321 need a generator mounted current transformer to provide quadrature droop characteristics for load sharing during parallel operation. Provision is also made for the connection of the STAMFORD power factor controller, for embedded applications, and a remote voltage trimmer.

WINDINGS & ELECTRICAL PERFORMANCE

All generator stators are wound to 2/3 pitch. This eliminates triplen (3rd, 9th, 15th ...) harmonics on the voltage waveform and is found to be the optimum design for trouble-free supply of non-linear loads. The 2/3 pitch design avoids excessive neutral currents sometimes seen with higher winding pitches. A fully connected damper winding reduces oscillations during paralleling. This winding, with the 2/3 pitch and carefully selected pole and tooth designs, ensures very low levels of voltage waveform distortion.

TERMINALS & TERMINAL BOX

Standard generators feature a main stator with 6 ends brought out to the terminals, which are mounted on the frame at the non-drive end of the generator. A sheet metal terminal box contains the AVR and provides ample space for the customers' wiring and gland arrangements. It has removable panels for easy access.

SHAFT & KEYS

All generator rotors are dynamically balanced to better than BS6861:Part 1 Grade 2.5 for minimum vibration in operation. Two bearing generators are balanced with a half key.

INSULATION/IMPREGNATION

The insulation system is class 'H', and meets the requirements of UL1446.

All wound components are impregnated with materials and processes designed specifically to provide the high build required for static windings and the high mechanical strength required for rotating components.

QUALITY ASSURANCE

Generators are manufactured using production procedures having a quality assurance level to BS EN ISO 9001.

NOTE ON REGULATION

The stated voltage regulation may not be maintained in the presence of certain radio transmitted signals. Any change in performance will fall within the limits of Criteria 'B' of EN 61000-6-2:2001. At no time will the steady-state voltage regulation exceed 2%.

NB Continuous development of our products entitles us to change specification details without notice, therefore they must not be regarded as binding.

Front cover drawing is typical of the product range.

PI734A
WINDING 312

CONTROL SYSTEM	SEPARATELY EXCITED BY P.M.G.		
A.V.R.	MX341	MX321	
VOLTAGE REGULATION	± 1%	± 0.5 %	With 4% ENGINE GOVERNING
SUSTAINED SHORT CIRCUIT	REFER TO SHORT CIRCUIT DECREMENT CURVES (page 7)		

INSULATION SYSTEM	CLASS H							
PROTECTION	IP23							
RATED POWER FACTOR	0.8							
STATOR WINDING	DOUBLE LAYER LAP							
WINDING PITCH	TWO THIRDS							
WINDING LEADS	6							
MAIN STATOR RESISTANCE	0.0016 Ohms PER PHASE AT 22°C STAR CONNECTED							
MAIN ROTOR RESISTANCE	1.67 Ohms at 22°C							
EXCITER STATOR RESISTANCE	17.5 Ohms at 22°C							
EXCITER ROTOR RESISTANCE	0.048 Ohms PER PHASE AT 22°C							
R.F.I. SUPPRESSION	BS EN 61000-6-2 & BS EN 61000-6-4,VDE 0875G, VDE 0875N. refer to factory for others							
WAVEFORM DISTORTION	NO LOAD < 1.5% NON-DISTORTING BALANCED LINEAR LOAD < 5.0%							
MAXIMUM OVERSPEED	2250 Rev/Min							
BEARING DRIVE END	BALL. 6228 C3							
BEARING NON-DRIVE END	BALL. 6319 C3							
	1 BEARING				2 BEARING			
WEIGHT COMP. GENERATOR	2760 kg				2710 kg			
WEIGHT WOUND STATOR	1306 kg				1306 kg			
WEIGHT WOUND ROTOR	1139 kg				1077 kg			
WR ² INERTIA	32.7498 kgm ²				31.7489 kgm ²			
SHIPPING WEIGHTS in a crate	2833kg				2779kg			
PACKING CRATE SIZE	194 x 105 x 154(cm)				194 x 105 x 154(cm)			
	50 Hz				60 Hz			
TELEPHONE INTERFERENCE	THF<2%				TIF<50			
COOLING AIR	2.69 m ³ /sec 5700 cfm				3.45 m ³ /sec 7300 cfm			
VOLTAGE STAR	380/220	400/231	415/240	440/254	416/240	440/254	460/266	480/277
kVA BASE RATING FOR REACTANCE VALUES	1225	1260	1260	1235	1370	1500	1510	1525
X _d DIR. AXIS SYNCHRONOUS	3.51	3.26	3.02	2.64	4.23	4.14	3.81	3.53
X' _d DIR. AXIS TRANSIENT	0.21	0.20	0.18	0.16	0.26	0.25	0.23	0.22
X'' _d DIR. AXIS SUBTRANSIENT	0.16	0.15	0.14	0.12	0.19	0.19	0.17	0.16
X _q QUAD. AXIS REACTANCE	2.26	2.10	1.95	1.70	2.73	2.67	2.46	2.28
X'' _q QUAD. AXIS SUBTRANSIENT	0.32	0.29	0.27	0.24	0.38	0.37	0.34	0.32
X _L LEAKAGE REACTANCE	0.04	0.04	0.03	0.03	0.05	0.05	0.04	0.04
X ₂ NEGATIVE SEQUENCE	0.22	0.21	0.19	0.17	0.27	0.26	0.24	0.23
X ₀ ZERO SEQUENCE	0.03	0.03	0.02	0.02	0.03	0.03	0.03	0.03
REACTANCES ARE SATURATED				VALUES ARE PER UNIT AT RATING AND VOLTAGE INDICATED				
T' _d TRANSIENT TIME CONST.	0.13s							
T'' _d SUB-TRANSTIME CONST.	0.01s							
T' _{do} O.C. FIELD TIME CONST.	2.14s							
T _a ARMATURE TIME CONST.	0.02s							
SHORT CIRCUIT RATIO	1/X _d							

**50
Hz**

PI734A
Winding 312



THREE PHASE EFFICIENCY CURVES

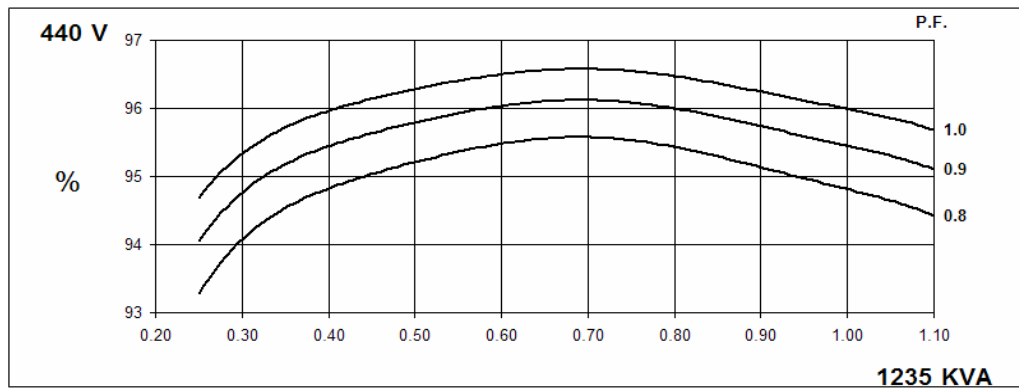
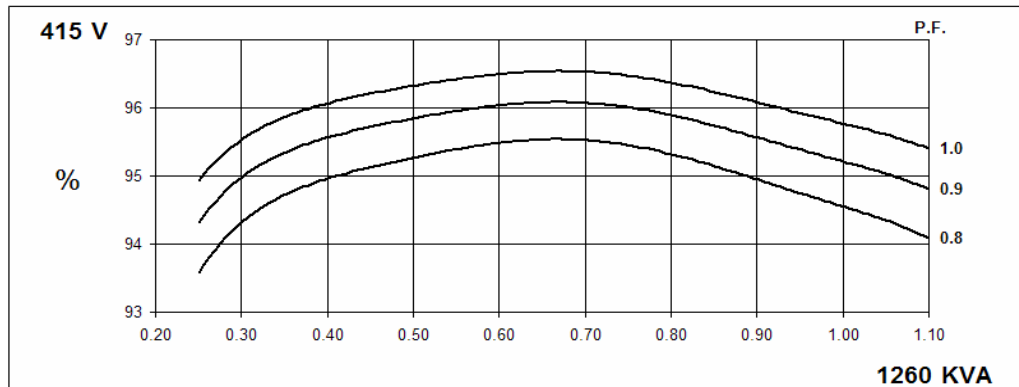
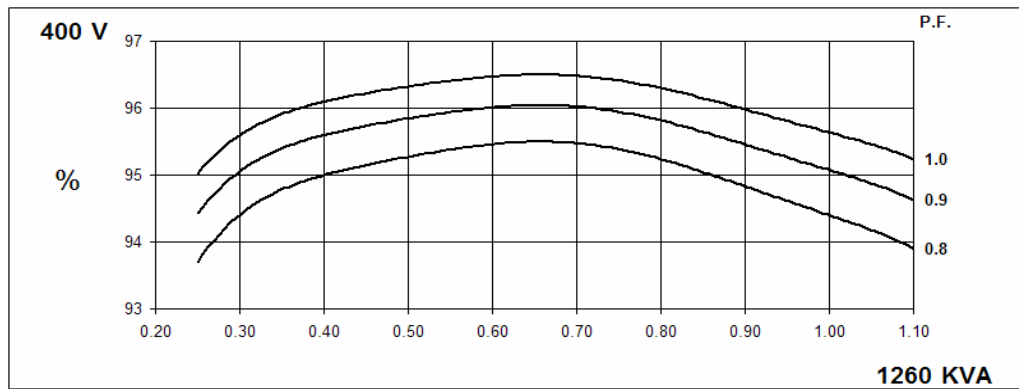
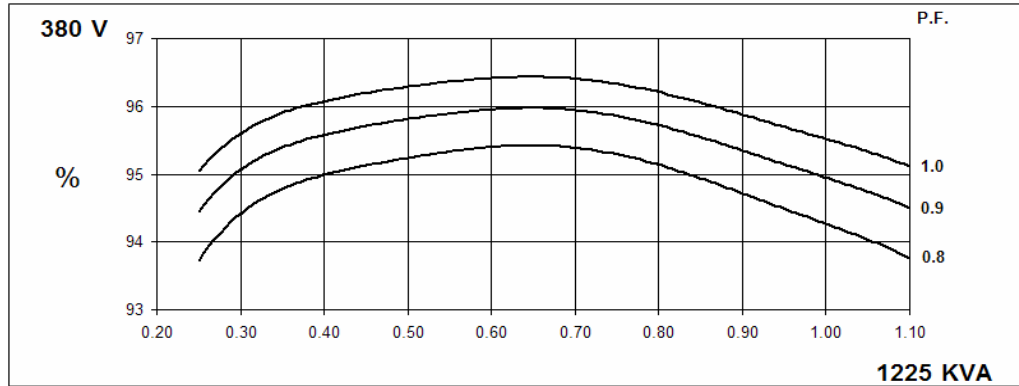

THREE PHASE EFFICIENCY CURVES

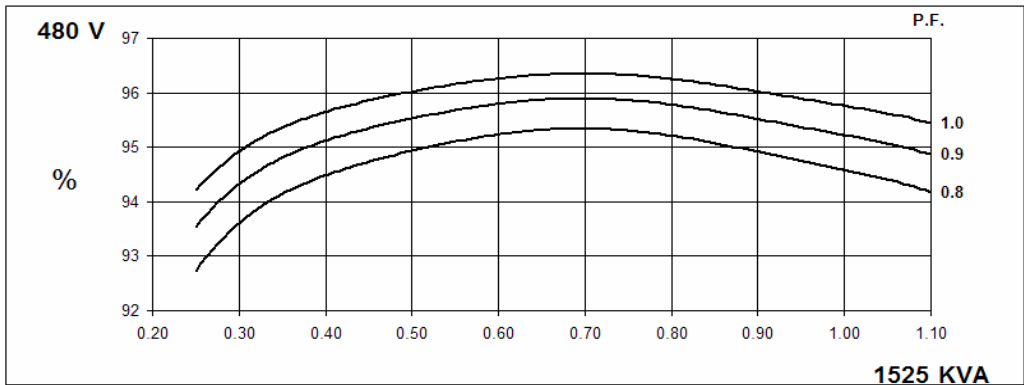
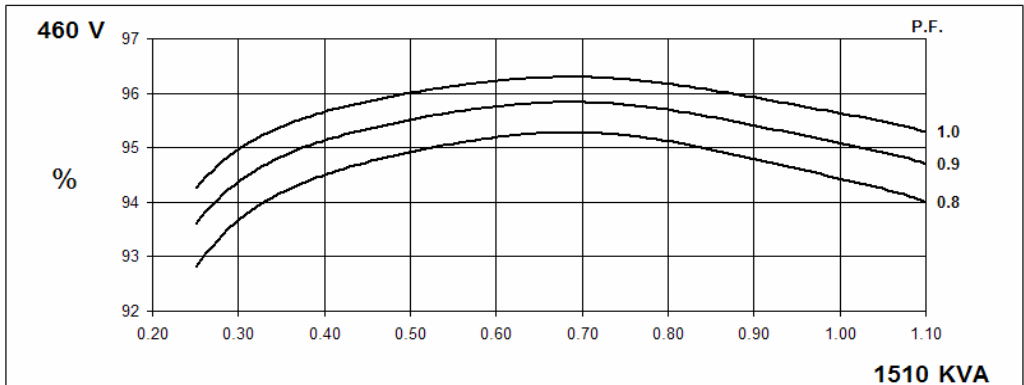
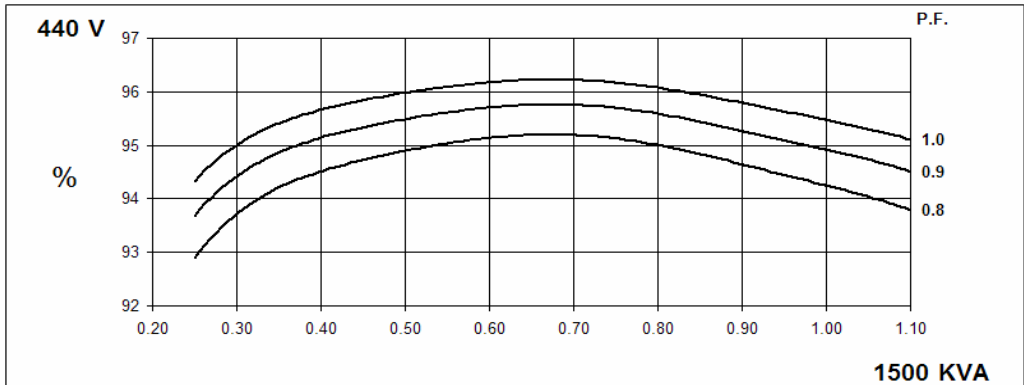
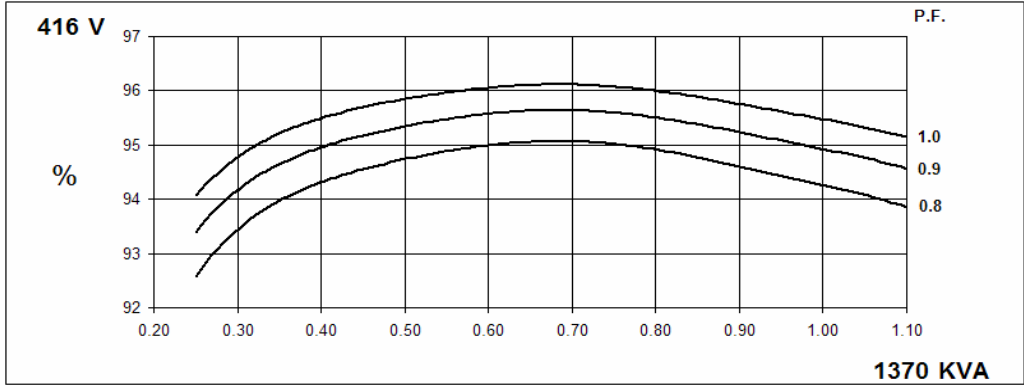

PI734A
Winding 312



Locked Rotor Motor Starting Curve

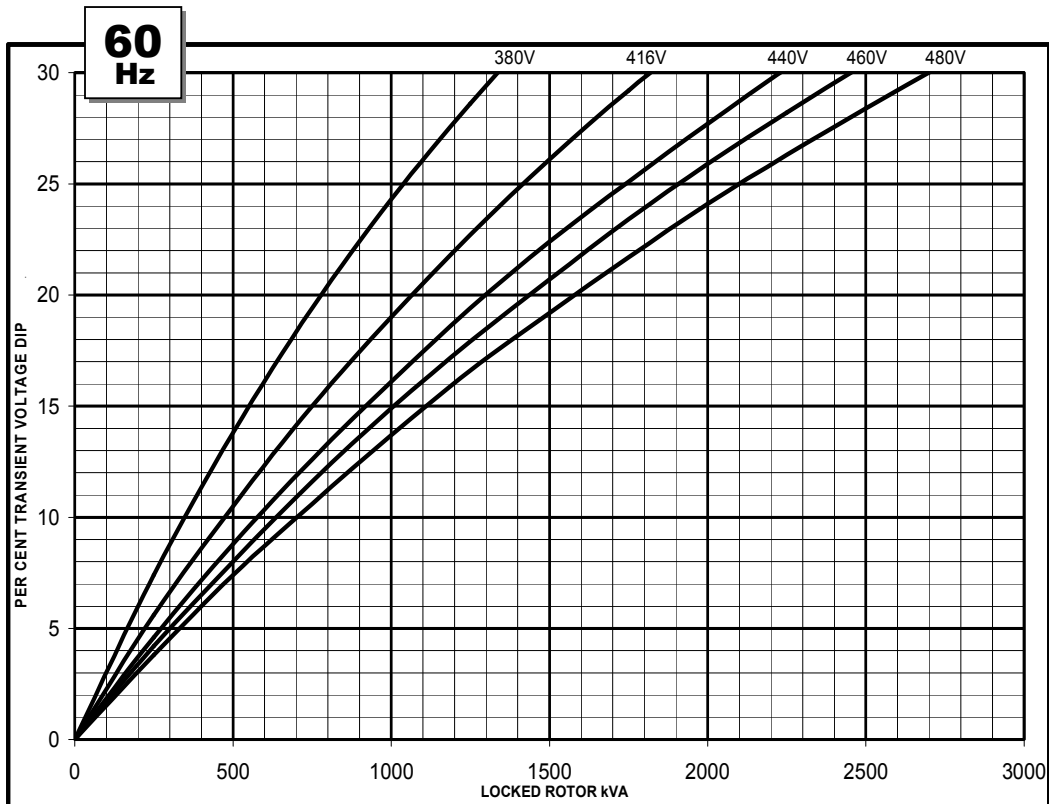

**Three-phase Short Circuit Decrement Curve. No-load Excitation at Rated Speed
Based on star (wye) connection.**

**50
Hz**

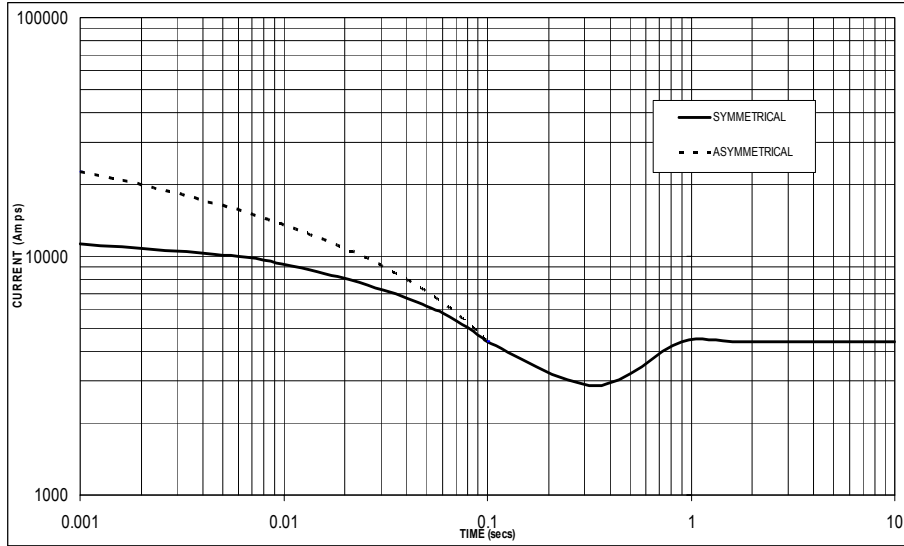

Sustained Short Circuit = 4,400 Amps

**60
Hz**

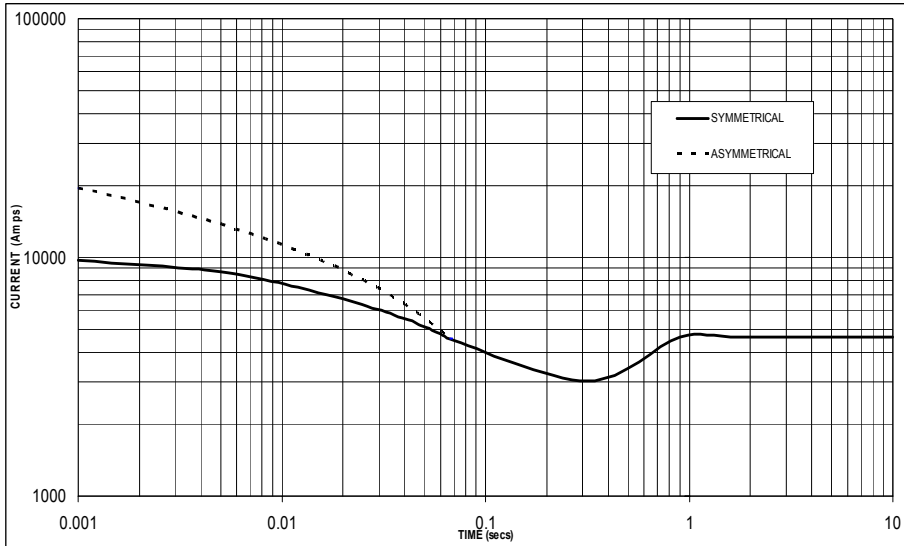

Sustained Short Circuit = 4,650 Amps

Note 1

The following multiplication factors should be used to adjust the values from curve between time 0.001 seconds and the minimum current point in respect of nominal operating voltage :

50Hz		60Hz	
Voltage	Factor	Voltage	Factor
380v	x 1.00	416v	x 1.00
400v	x 1.05	440v	x 1.06
415v	x 1.09	460v	x 1.10
440v	x 1.16	480v	x 1.15

The sustained current value is constant irrespective of voltage level

Note 2

The following multiplication factor should be used to convert the values calculated in accordance with NOTE 1 to those applicable to the various types of short circuit :

	3-phase	2-phase L-L	1-phase L-N
Instantaneous	x 1.00	x 0.87	x 1.30
Minimum	x 1.00	x 1.80	x 3.20
Sustained	x 1.00	x 1.50	x 2.50
Max. sustained duration	10 sec.	5 sec.	2 sec.

All other times are unchanged

Note 3

Curves are drawn for Star (Wye) connected machines.

PI734A

Winding 312 / 0.8 Power Factor



RATINGS

Class - Temp Rise		Cont. F - 105/40°C				Cont. H - 125/40°C				Standby - 150/40°C				Standby - 163/27°C			
50Hz	Star (V)	380	400	415	440	380	400	415	440	380	400	415	440	380	400	415	440
	kVA	1140	1175	1175	1150	1225	1260	1260	1235	1275	1315	1315	1290	1310	1350	1350	1325
	kW	912	940	940	920	980	1008	1008	988	1020	1052	1052	1032	1048	1080	1080	1060
	Efficiency (%)	94.5	94.6	94.8	95.0	94.3	94.4	94.6	94.8	94.1	94.2	94.4	94.7	94.0	94.1	94.3	94.6
	kW Input	965	994	992	968	1039	1068	1066	1042	1084	1117	1114	1090	1115	1148	1145	1121

60Hz	Star (V)	416	440	460	480	416	440	460	480	416	440	460	480	416	440	460	480
	kVA	1275	1395	1405	1415	1370	1500	1510	1525	1425	1560	1570	1585	1465	1605	1615	1630
	kW	1020	1116	1124	1132	1096	1200	1208	1220	1140	1248	1256	1268	1172	1284	1292	1304
	Efficiency (%)	94.5	94.5	94.6	94.8	94.3	94.2	94.4	94.6	94.1	94.1	94.3	94.5	94.0	94.0	94.2	94.4
	kW Input	1079	1181	1188	1194	1162	1274	1280	1290	1211	1326	1332	1342	1247	1366	1372	1381

DIMENSIONS

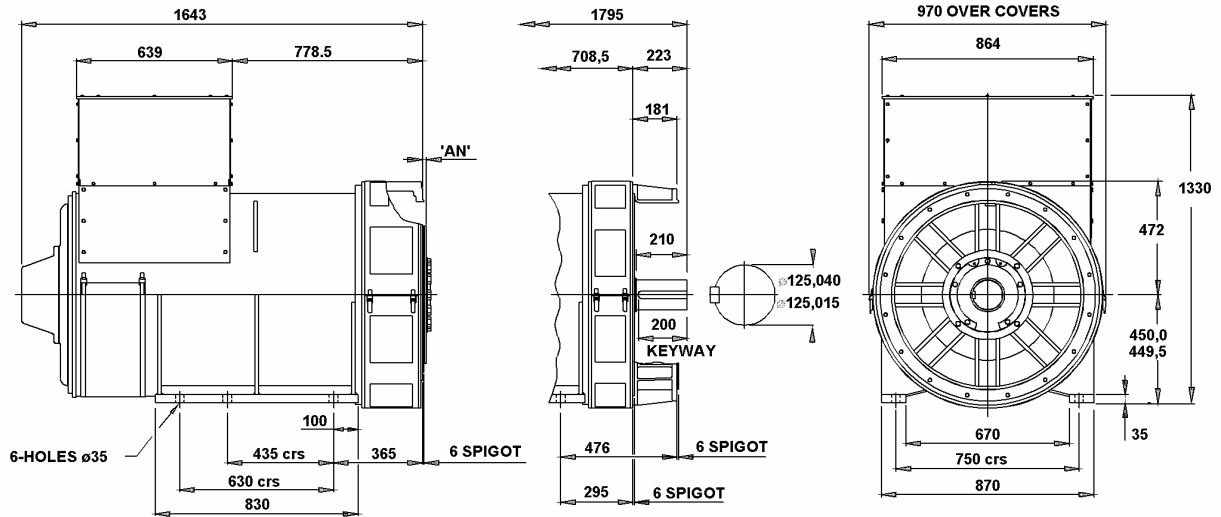

COUPLING DISC	'AN'
S.A.E No 18	15,7
S.A.E No 21	0
S.A.E No 24	0

1-BRG ADAPTORS
S.A.E No 0
S.A.E No 00

2-BRG ADAPTORS
S.A.E No 0
S.A.E No 00



Barnack Road • Stamford • Lincolnshire • PE9 2NB
 Tel: 00 44 (0)1780 484000 • Fax: 00 44 (0)1780 484100
 Website: www.newage-avkseg.com