

4000 Series 4008TAG1A/2A Diesel Engine – Electropak

844 kWm 1500 rev/min TAG1A

924 kWm 1500 rev/min TAG2A

Emission Compliant

The Perkins 4000 Series family of 6, 8, 12 and 16 cylinder diesel engines was designed in advance of today's uncompromising demands within the power generation industry and includes superior performance and reliability.

The 4008TAG1A/2A Electropaks are turbo-charged, air-to-air charge cooled, 8 cylinder in-line diesel engines. Offered with either Temperate or Tropical cooling packages (with or without fuel cooling). Their premium design and specification features provide economic and durable operation as well as exceptional power to weight ratio, improved serviceability, low gaseous emissions, overall performance and reliability essential to the power generation market.

Economic power

- Individual four valve per cylinder heads give optimised gas flows, whilst digitally governed unit fuel injectors ensure ultra fine fuel atomisation and hence controlled rapid combustion, for efficiency and economy
- Commonality of components with other engines in the 4000 Series family allows reduced parts stocking levels

Reliable power

- Developed and tested using latest engineering techniques
- Piston temperatures are controlled by an advanced gallery jet cooling system
- All engines are tolerant of a wide range of temperatures without derate
- Perkins global product support is designed to enhance the customer experience of owning a Perkins powered machine. We deliver this through the quality of our distribution network, extensive global coverage and a range of Perkins supported OEM partnership options. So whether you are an end-user or an equipment manufacturer our engine expertise is essential to your success

Clean, efficient power

- Exceptional power to weight ratio and compact size for easier transportation and installation
- New designed radiator assemblies with corrosion inhibiting powder coated surfaces; fewer pipe joints and easier access to reduce maintenance times
- Designed to provide excellent service access for ease of maintenance
- Engines designed to comply with major international standards
- Low gaseous emissions for cleaner operation

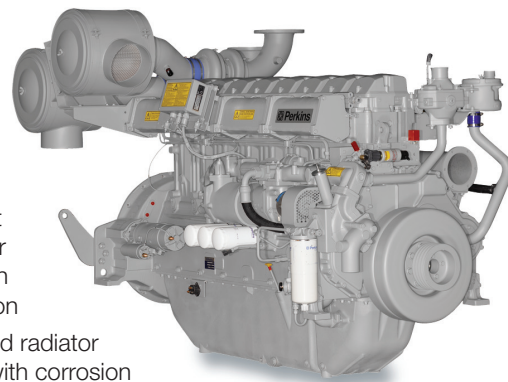

Engine Model Rated Speed Radiator Type	Type of Operation	Typical Generator Output (Net)		Engine Power			
				Gross		Net	
		kVA	kWe	kWm	bhp	kWm	bhp
4008TAG1A 1500 rev/min Tropical	Baseload Power	720	576	644	864	602	807
	Prime Power	911	728	805	1080	767	1029
	Standby (maximum)	1002	802	882	1183	844	1132
4008TAG2A 1500 rev/mim Tropical	Baseload Power	809	647	719	964	681	913
	Prime Power	1022	818	899	1206	861	1155
	Standby (maximum)	1093	874	962	1290	924	1239

The above ratings represent the engine performance capabilities guaranteed within plus or minus 3% at the reference conditions equivalent to those specified in ISO 8528/1, ISO 3046/1, BS5514/1.

Rating conditions: 25°C air inlet temperature, barometric pressure 100 kPa, relative humidity 30%. Please consult your distributor or the factory for ratings in other ambient conditions.

Note: For full ratings please refer to Perkins Engines Company Limited. All electrical ratings are based on an average alternator efficiency and a power factor of 0.8.

Full specification: BS2869: Class A1 + A2 or ASTM D975 No 2D.

Rating Definitions

Baseload Power: Power available for continuous full load operation. No overload is permitted. **Prime Power:** Power available for variable load with an average load factor not exceeding 80% of the prime power rating in any 24 hour period. Overload of 10% permitted for one hour in every twelve hours operation. **Standby (maximum):** Power available at variable load in the event of a main power network failure up to a maximum of 500 hours per year. No overload is permitted.

Photographs are for illustrative purposes only and may not reflect final specification.

All information in this document is substantially correct at time of printing and may be altered subsequently.

Publication No. PN1833/09/12 Produced in England ©2012 Perkins Engines Company Limited

 **Perkins**[®]

THE HEART OF EVERY GREAT MACHINE

4000 Series 4008TAG1A/2A Diesel Engine – Electropak

844 kWm 1500 rev/min TAG1A
 924 kWm 1500 rev/min TAG2A
 Emission Compliant

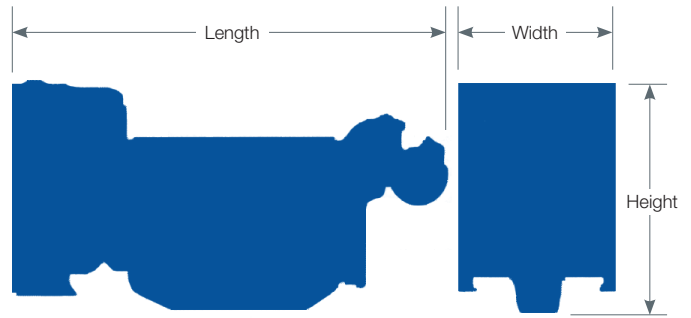
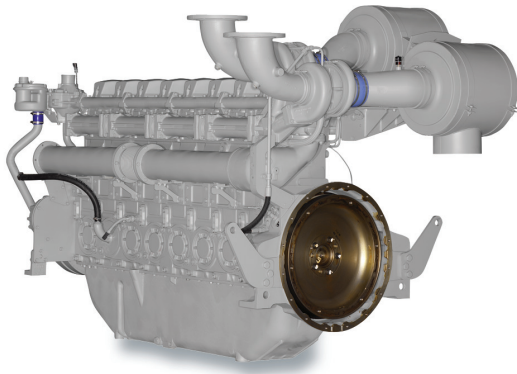

See General data

Standard Electropak specification

Air inlet

- Mounted oil filters and turbochargers

Fuel system

- Unit fuel injectors with lift pump and hand stop control
- Digital electronic governor to ISO 3046 Part 4 Class A1
- Full-flow spin-on fuel oil filters

Lubrication system

- Wet sump with filler and dipstick
- Full-flow spin-on oil filters
- Engine jacket water/lub oil temperature stabiliser

Cooling system

- Gear driven circulating pump
- Twin thermostats
- Crankshaft pulley for fan drive
- Powder coated radiator assemblies comprising: water radiator; air charge cooled radiator; fuel oil cooling (optional); all pipes, hoses and clips; fan; pulley; fan belts and safety guards

Electrical system

- 24 volt starter motor and 24 volt/40 amp alternator with integral regulator and DC output
- 24 volt combined high coolant temperature/low oil pressure switch
- Overspeed switch and magnetic pickup
- Turbine inlet temperature shutdown switch
- 24 volt stop solenoid (energised to run)

Flywheel and housing

- Flywheel to SAE J620 size 18
- SAE 0 flywheel housing

Optional equipment

Other optional extra equipment available:

Choice of Temperate or Tropical radiators available dependent on operational cooling requirements
 Fuel oil cooling radiator available integral to radiator assemblies
 Twin heavy duty air cleaner – paper element with pre-cleaner
 Changeover lubricating oil filter
 Changeover fuel oil filter
 Immersion heater with thermostat
 Air starters
 Instrument panel

Note: This list is not exhaustive, further options may be available to meet particular applications on enquiry to Perkins Sales Department

4008TAG1A (1500 rev/min)		
Fuel Consumption for Temperate and Tropical		
Engine Speed	g/kWh	litres/hr
At Standby Maximum Power Rating	210	218
At Prime Power Rating	206	195
At Continuous Baseload Rating	203	154
At 75% of Prime Power Rating	201	143
At 50% of Prime Power Rating	207	98
At 25% of Prime Power Rating	217	52

4008TAG2A (1500 rev/min)		
Fuel Consumption for Temperate and Tropical		
Engine Speed	g/kWh	litres/hr
At Standby Maximum Power Rating	221	286
At Prime Power Rating	214	226
At Continuous Baseload Rating	205	175
At 75% of Prime Power Rating	203	163
At 50% of Prime Power Rating	206	109
At 25% of Prime Power Rating	218	59

General data

Number of cylinders 8 vertical in-line
 Bore and stroke 160 mm x 190 mm
 Displacement 30.561 litres
 Aspiration Turbocharged and air-to-air charge cooled
 Cycle 4 stroke
 Combustion system Direct injection
 Compression ratio 13.6:1
 Rotation Anti-clockwise viewed from flywheel end
 Cooling system Water-cooled
 Total lubrication system capacity 153 litres
 Temperate cooling Tropical cooling
 Ambient coolant clearance TAG1A 41°C 50°C
 Ambient coolant clearance TAG2A 35°C 50°C
 Total coolant capacity 143 litres 149 litres
 Dimensions – Length 3852 mm 3711 mm
 Width 2046 mm 2046 mm
 Height 2067 mm 2146 mm
 Dry weight 4270 kg * 4320 kg *

* For fuel cooler, add 6 kg

Final weight and dimensions will depend on completed specification

Photographs are for illustrative purposes only and may not reflect final specification.

All information in this document is substantially correct at time of printing and may be altered subsequently.
 Publication No. PN1833/09/12 Produced in England
 ©2012 Perkins Engines Company Limited

Perkins Engines Company Limited

Peterborough PE1 5FQ
 United Kingdom
 Telephone +44 (0)1733 583000
 Fax +44 (0)1733 582240

www.perkins.com



THE HEART OF EVERY GREAT MACHINE

HCI634J - Technical Data Sheet

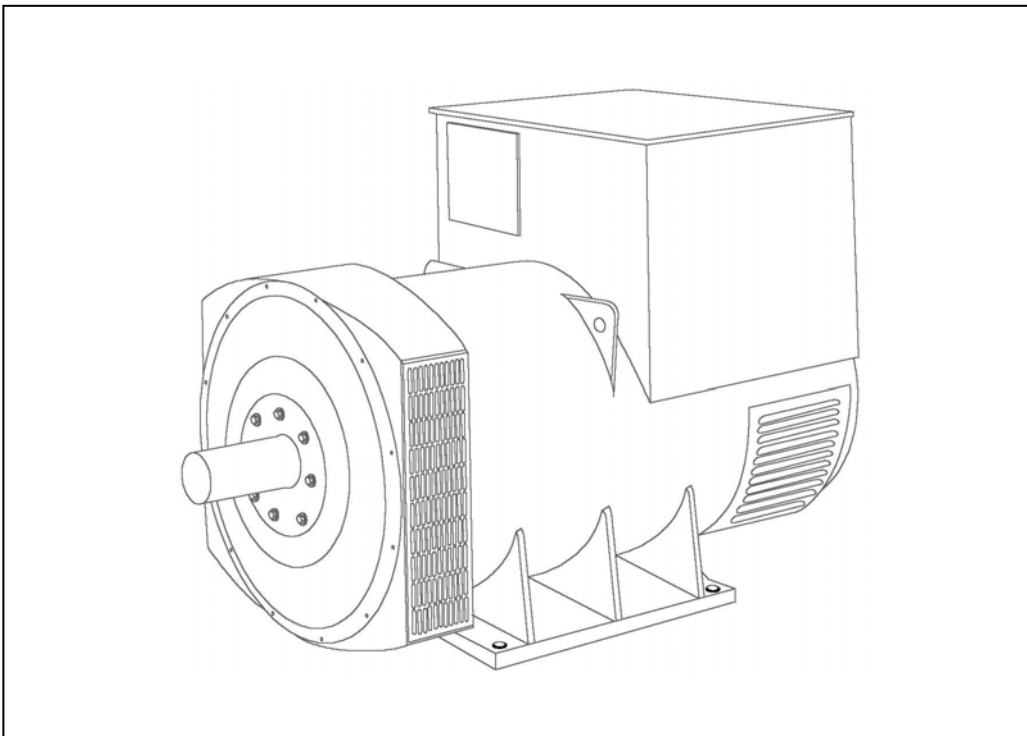

HCI634J

SPECIFICATIONS & OPTIONS



STANDARDS

Newage Stamford industrial generators meet the requirements of BS EN 60034 and the relevant section of other international standards such as BS5000, VDE 0530, NEMA MG1-32, IEC34, CSA C22.2-100, AS1359. Other standards and certifications can be considered on request.

VOLTAGE REGULATORS

MX321 AVR - STANDARD

This sophisticated Automatic Voltage Regulator (AVR) is incorporated into the Stamford Permanent Magnet Generator (PMG) system and is fitted as standard to generators of this type.

The PMG provides power via the AVR to the main exciter, giving a source of constant excitation power independent of generator output. The main exciter output is then fed to the main rotor, through a full wave bridge, protected by a surge suppressor. The AVR has in-built protection against sustained over-excitation, caused by internal or external faults. This de-excites the machine after a minimum of 5 seconds.

Over voltage protection is built-in and short circuit current level adjustments is an optional facility.

WINDINGS & ELECTRICAL PERFORMANCE

All generator stators are wound to 2/3 pitch. This eliminates triplen (3rd, 9th, 15th ...) harmonics on the voltage waveform and is found to be the optimum design for trouble-free supply of non-linear loads. The 2/3 pitch design avoids excessive neutral currents sometimes seen with higher winding pitches, when in parallel with the mains. A fully connected damper winding reduces oscillations during paralleling. This winding, with the 2/3 pitch and carefully selected pole and tooth designs, ensures very low waveform distortion.

TERMINALS & TERMINAL BOX

Standard generators feature a main stator with 6 ends brought out to the terminals, which are mounted on the frame at the non-drive end of the generator. A sheet steel terminal box contains the AVR and provides ample space for the customers' wiring and gland arrangements. It has removable panels for easy access.

SHAFT & KEYS

All generator rotors are dynamically balanced to better than BS6861:Part 1 Grade 2.5 for minimum vibration in operation. Two bearing generators are balanced with a half key.

INSULATION/IMPREGNATION

The insulation system is class 'H'.

All wound components are impregnated with materials and processes designed specifically to provide the high build required for static windings and the high mechanical strength required for rotating components.

QUALITY ASSURANCE

Generators are manufactured using production procedures having a quality assurance level to BS EN ISO 9001.

The stated voltage regulation may not be maintained in the presence of certain radio transmitted signals. Any change in performance will fall within the limits of Criteria 'B' of EN 61000-6-2:2001. At no time will the steady-state voltage regulation exceed 2%.

NB Continuous development of our products entitles us to change specification details without notice, therefore they must not be regarded as binding.

Front cover drawing typical of product range.

HCI634J
WINDING 312

CONTROL SYSTEM	SEPARATELY EXCITED BY P.M.G.		
A.V.R.	MX321		
VOLTAGE REGULATION	± 0.5 %	With 4% ENGINE GOVERNING	
SUSTAINED SHORT CIRCUIT	REFER TO SHORT CIRCUIT DECREMENT CURVES (page 7)		

INSULATION SYSTEM	CLASS H							
PROTECTION	IP23							
RATED POWER FACTOR	0.8							
STATOR WINDING	DOUBLE LAYER LAP							
WINDING PITCH	TWO THIRDS							
WINDING LEADS	6							
STATOR WDG. RESISTANCE	0.002 Ohms PER PHASE AT 22°C STAR CONNECTED							
ROTOR WDG. RESISTANCE	2.09 Ohms at 22°C							
R.F.I. SUPPRESSION	BS EN 61000-6-2 & BS EN 61000-6-4, VDE 0875G, VDE 0875N. refer to factory for others							
WAVEFORM DISTORTION	NO LOAD < 1.5% NON-DISTORTING BALANCED LINEAR LOAD < 5.0%							
MAXIMUM OVERSPEED	2250 Rev/Min							
BEARING DRIVE END	BALL. 6224 (ISO)							
BEARING NON-DRIVE END	BALL. 6317 (ISO)							
	1 BEARING				2 BEARING			
WEIGHT COMP. GENERATOR	2279 kg				2300 kg			
WEIGHT WOUND STATOR	1120 kg				1120 kg			
WEIGHT WOUND ROTOR	962 kg				916 kg			
WR ² INERTIA	22.9287 kgm ²				22.3814 kgm ²			
SHIPPING WEIGHTS in a crate	2328kg				2329kg			
PACKING CRATE SIZE	183 x 92 x 140(cm)				183 x 92 x 140(cm)			
	50 Hz				60 Hz			
TELEPHONE INTERFERENCE	THF<2%				TIF<50			
COOLING AIR	1.614 m ³ /sec 3420 cfm				1.961 m ³ /sec 4156 cfm			
VOLTAGE STAR	380/220	400/231	415/240	440/254	416/240	440/254	460/266	480/277
VOLTAGE DELTA	220	230	240	254	240	254	266	277
kVA BASE RATING FOR REACTANCE VALUES	1000	1000	1000	1000	1150	1200	1250	1300
X _d DIR. AXIS SYNCHRONOUS	3.02	2.73	2.54	2.26	3.49	3.25	3.10	2.96
X' _d DIR. AXIS TRANSIENT	0.24	0.22	0.20	0.18	0.28	0.26	0.25	0.24
X'' _d DIR. AXIS SUBTRANSIENT	0.17	0.15	0.14	0.12	0.19	0.18	0.17	0.16
X _q QUAD. AXIS REACTANCE	1.78	1.61	1.50	1.33	2.05	1.91	1.82	1.74
X'' _q QUAD. AXIS SUBTRANSIENT	0.21	0.19	0.18	0.16	0.25	0.23	0.22	0.21
X _L LEAKAGE REACTANCE	0.09	0.08	0.08	0.07	0.10	0.10	0.09	0.09
X ₂ NEGATIVE SEQUENCE	0.21	0.19	0.18	0.16	0.25	0.23	0.22	0.21
X ₀ ZERO SEQUENCE	0.03	0.02	0.02	0.02	0.03	0.03	0.03	0.03
REACTANCES ARE SATURATED VALUES ARE PER UNIT AT RATING AND VOLTAGE INDICATED								
T' _d TRANSIENT TIME CONST.	0.185							
T'' _d SUB-TRANSTIME CONST.	0.025							
T' _{do} O.C. FIELD TIME CONST.	3.03							
T _a ARMATURE TIME CONST.	0.046							
SHORT CIRCUIT RATIO	1/X _d							

**50
Hz**

HCI634J
Winding 312



THREE PHASE EFFICIENCY CURVES

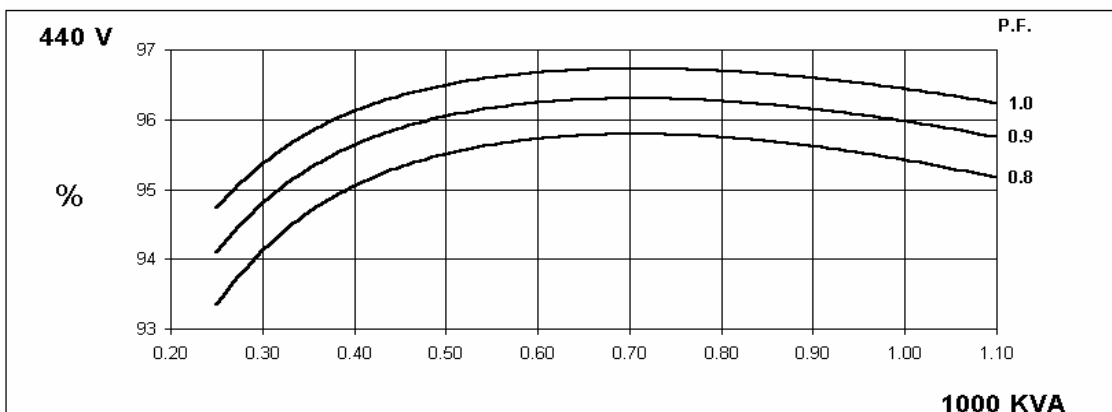
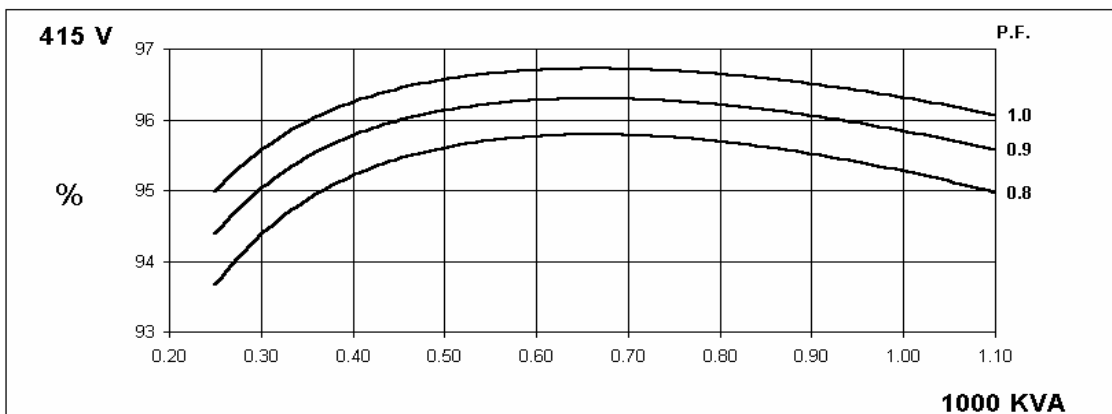
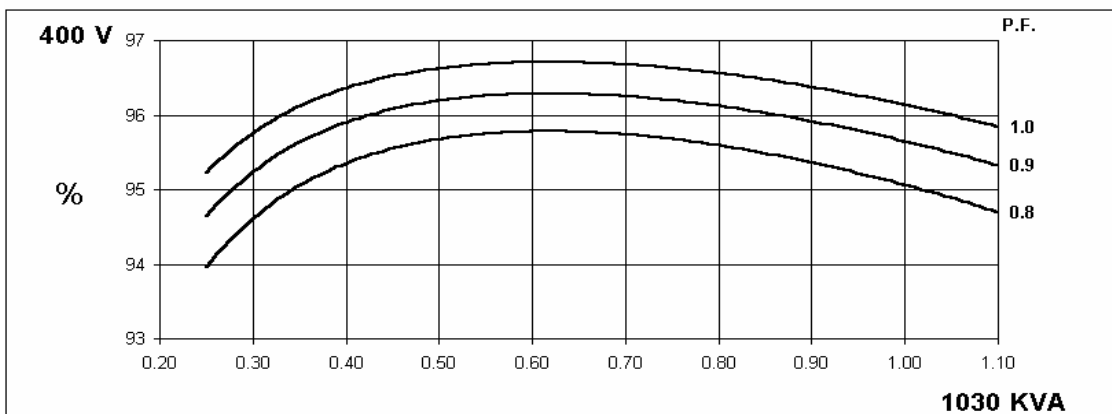
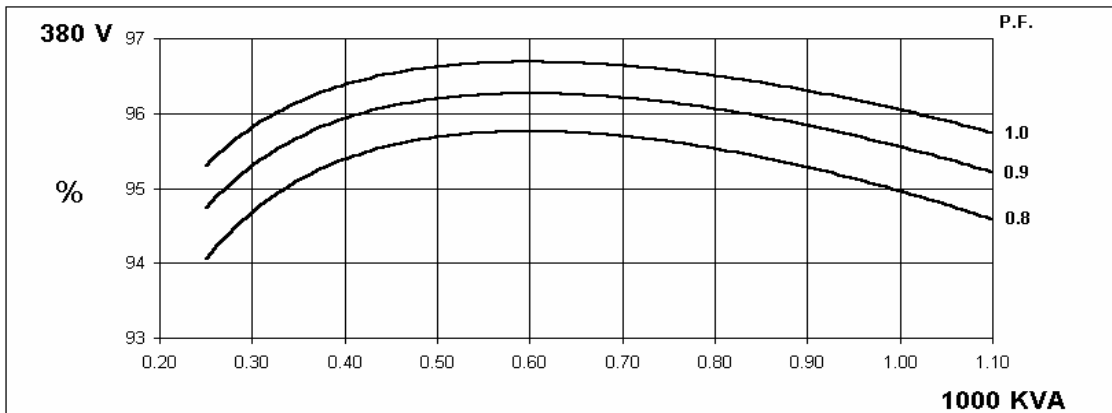

THREE PHASE EFFICIENCY CURVES

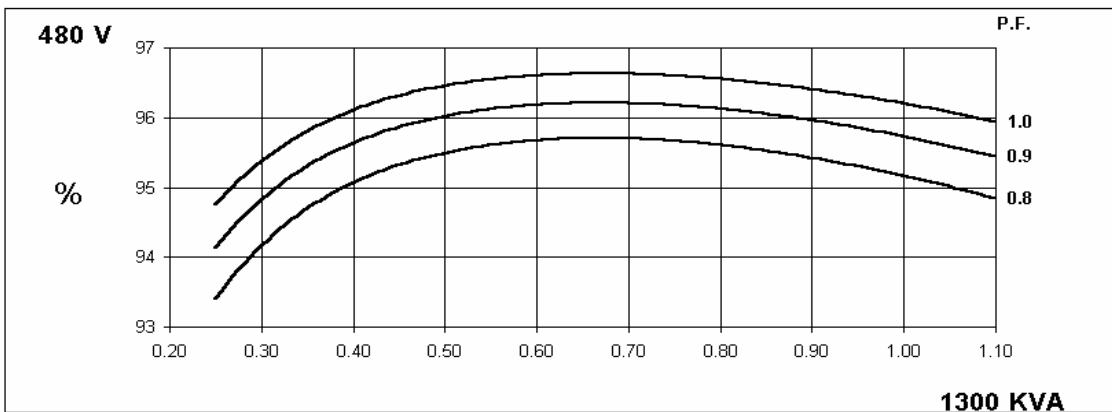
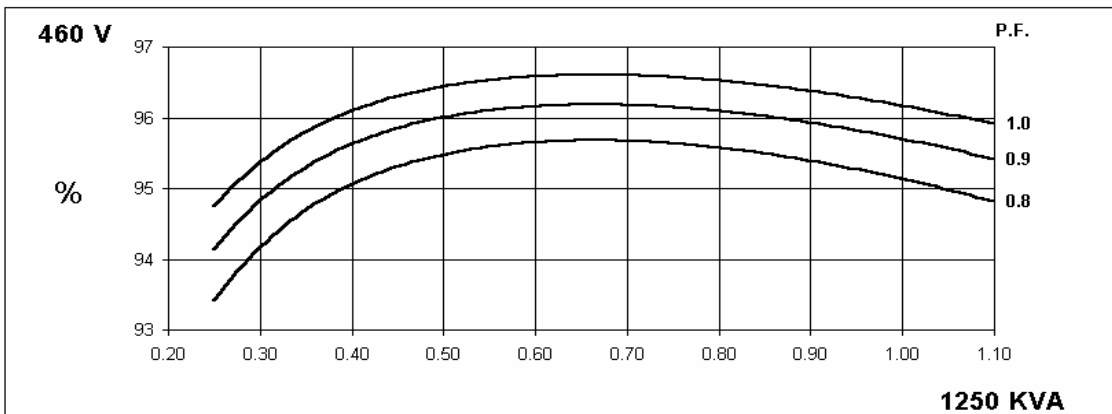
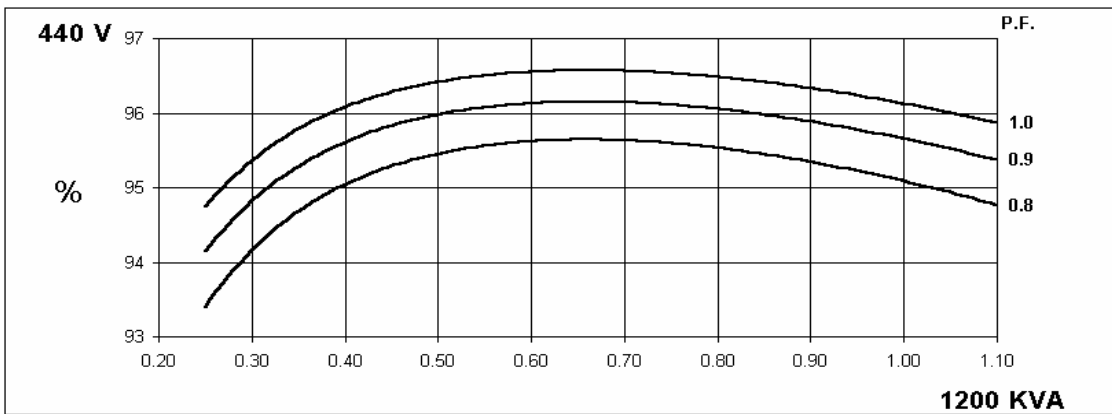
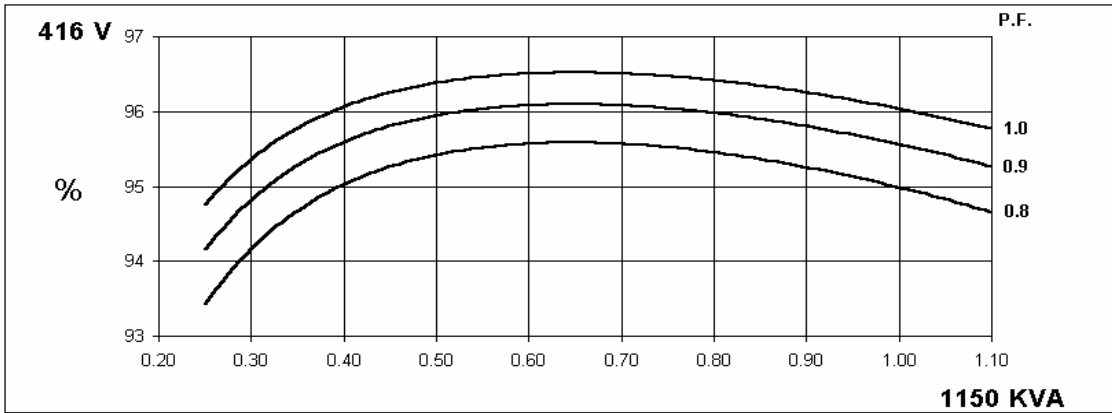

HCI634J

Winding 312



Locked Rotor Motor Starting Curve

**50
Hz**

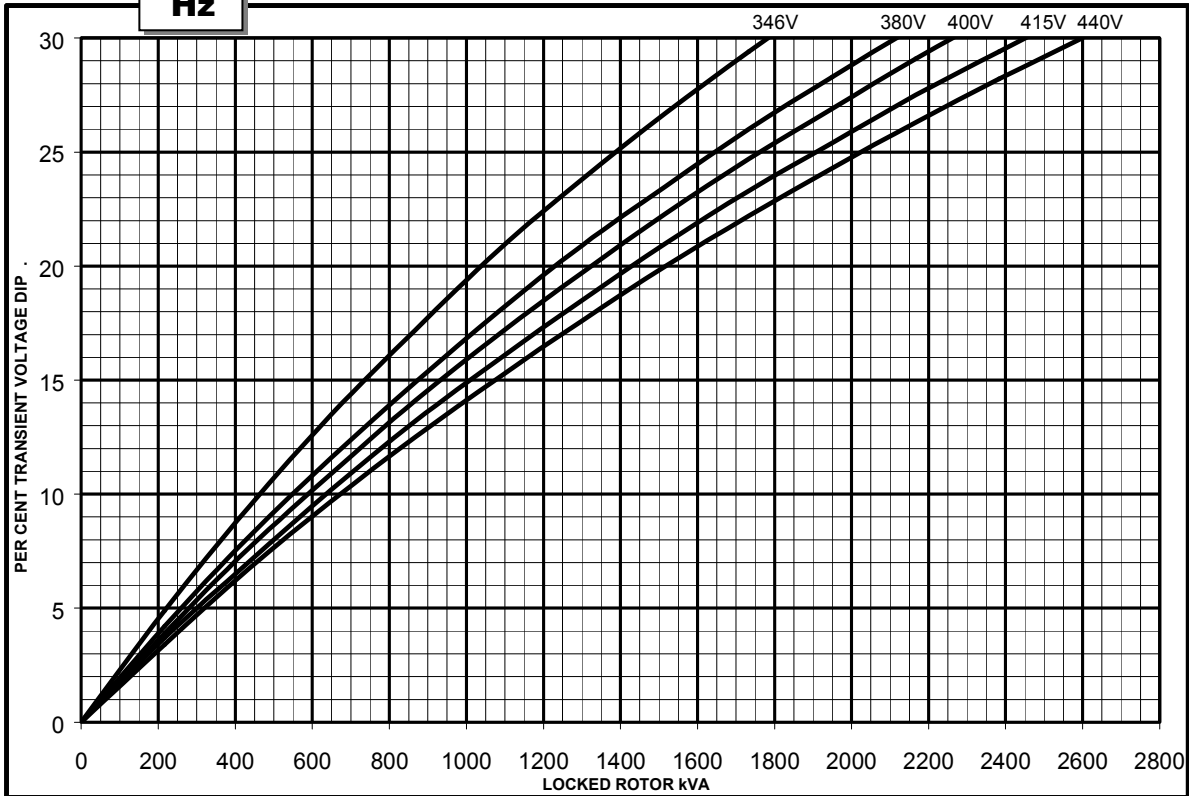

**60
Hz**

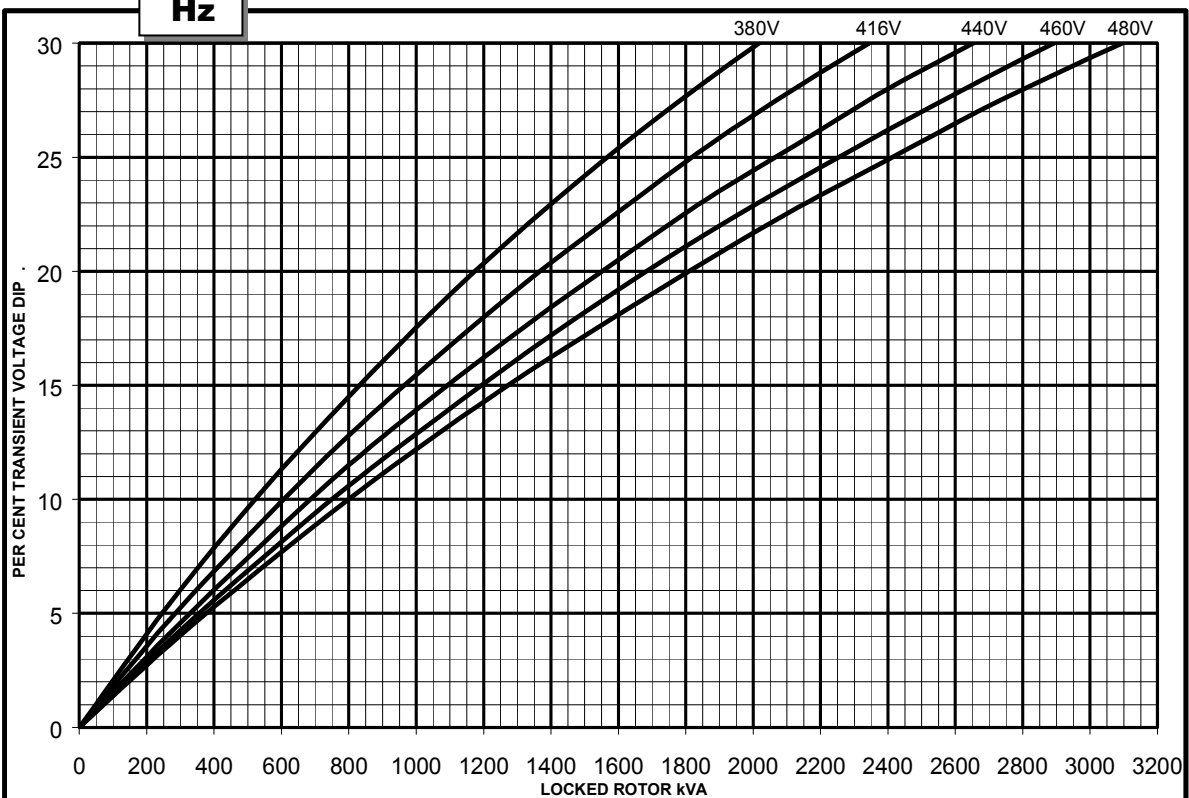

**Three-phase Short Circuit Decrement Curve. No-load Excitation at Rated Speed
Based on star (wye) connection.**

**50
Hz**

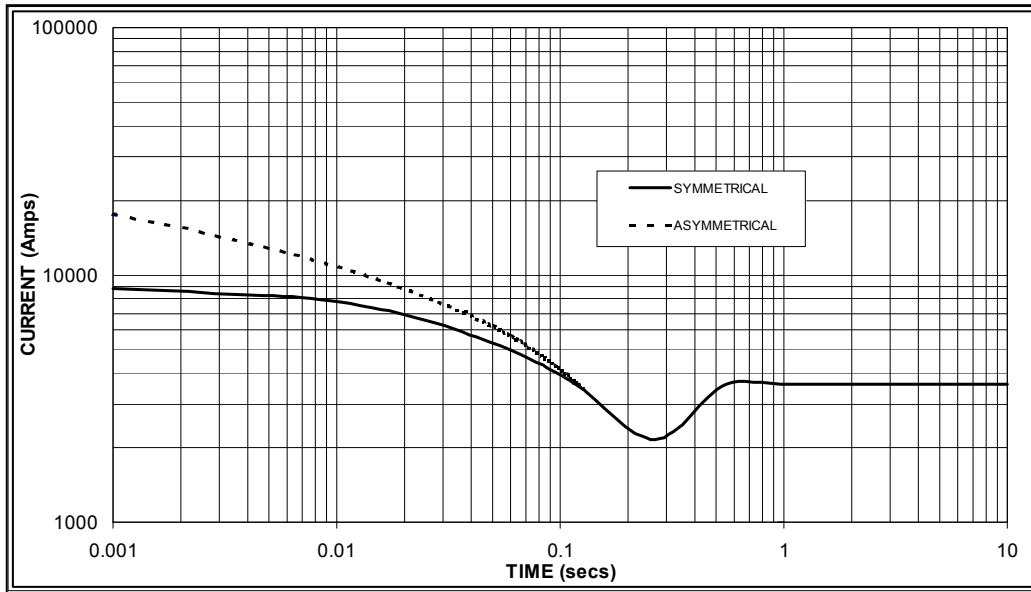

Sustained Short Circuit = 3,600 Amps

**60
Hz**

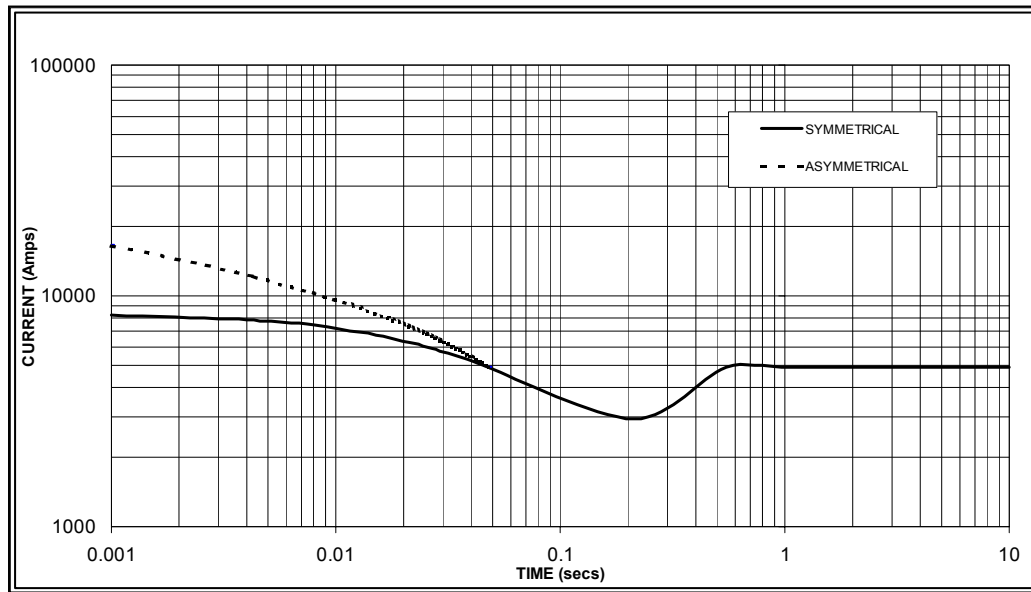

Sustained Short Circuit = 4,900 Amps

Note 1

The following multiplication factors should be used to adjust the values from curve between time 0.001 seconds and the minimum current point in respect of nominal operating voltage :

50Hz		60Hz	
Voltage	Factor	Voltage	Factor
380v	X 1.00	416v	x 1.00
400v	X 1.07	440v	x 1.06
415v	X 1.12	460v	x 1.12
440v	X 1.18	480v	x 1.17

The sustained current value is constant irrespective of voltage level

Note 2

The following multiplication factor should be used to convert the values calculated in accordance with NOTE 1 to those applicable to the various types of short circuit :

	3-phase	2-phase L-L	1-phase L-N
Instantaneous	x 1.00	x 0.87	x 1.30
Minimum	x 1.00	x 1.80	x 3.20
Sustained	x 1.00	x 1.50	x 2.50
Max. sustained duration	10 sec.	5 sec.	2 sec.

All other times are unchanged

Note 3

Curves are drawn for Star (Wye) connected machines.
For Delta connection multiply the Curve current value by 1.732

HCI634J

Winding 312 0.8 Power Factor



RATINGS

Class - Temp Rise		Cont. F - 105/40°C				Cont. H - 125/40°C				Standby - 150/40°C				Standby - 163/27°C			
50Hz	Star (V)	380	400	415	440	380	400	415	440	380	400	415	440	380	400	415	440
	Delta (V)	220	230	240	254	220	230	240	254	220	230	240	254	220	230	240	254
	kVA	900	927	900	900	1000	1030	1000	1000	1060	1070	1060	1060	1100	1110	1100	1100
	kW	720	742	720	720	800	824	800	800	848	856	848	848	880	888	880	880
	Efficiency (%)	95.3	95.4	95.5	95.6	95.0	95.1	95.3	95.4	94.7	94.9	95.1	95.3	94.6	94.8	95.0	95.2
	kW Input	756	777	754	753	842	866	839	839	895	902	892	890	930	937	926	924
60Hz	Star (V)	416	440	460	480	416	440	460	480	416	440	460	480	416	440	460	480
	Delta (V)	240	254	266	277	240	254	266	277	240	254	266	277	240	254	266	277
	kVA	1063	1100	1150	1188	1150	1200	1250	1300	1206	1250	1300	1350	1250	1300	1350	1400
	kW	850	880	920	950	920	960	1000	1040	965	1000	1040	1080	1000	1040	1080	1120
	Efficiency (%)	95.2	95.3	95.3	95.4	95.0	95.1	95.1	95.2	94.8	95.0	95.0	95.1	94.7	94.8	94.9	94.9
	kW Input	893	923	965	996	968	1009	1052	1092	1018	1053	1095	1136	1056	1097	1138	1180

DIMENSIONS

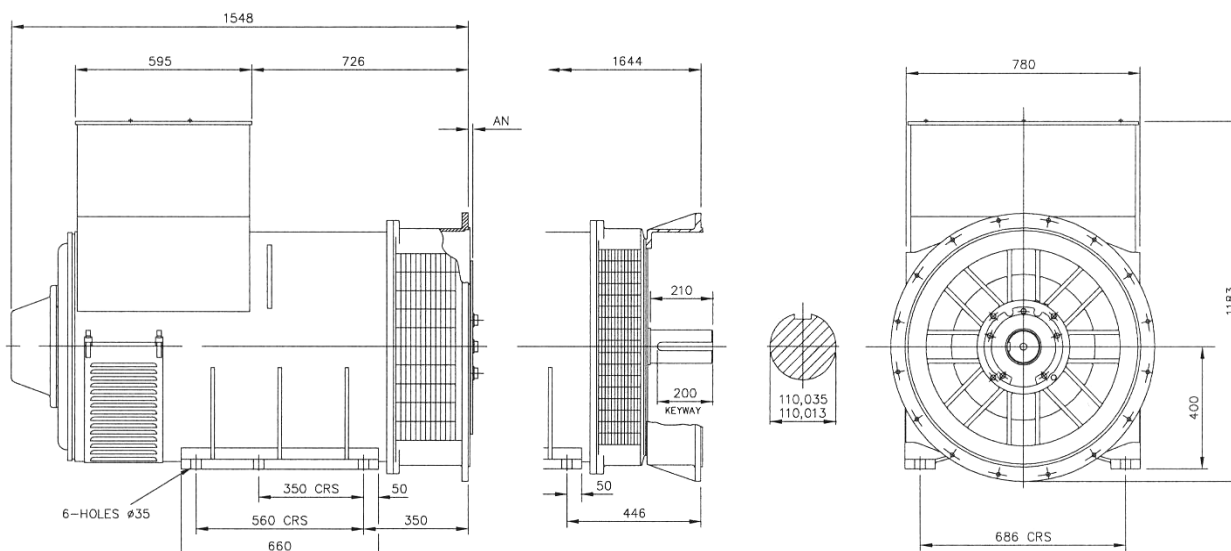

SAE	14	18	21	24
AN	25.4	15.87	0	0



PO Box 17 • Barnack Road • Stamford • Lincolnshire • PE9 2NB

Tel: 00 44 (0)1780 484000 • Fax: 00 44 (0)1780 484100

Website: www.newage-avkseg.com