

1500 Series 1506A-E88TAG5 ElectropaK

293 kWm standby net power @ 1500 rpm

Building upon Perkins proven reputation within the power generation industry the Perkins® 1500 Series ElectropaK engines now fit even closer to our customer's needs.

The 1506A-E88TAG5 ElectropaK is a 6 cylinder, fully electronic, turbocharged, air-to-air charge cooled diesel engine. It is economical, quiet and reliable and provides the high performance that is demanded by our customers for their power generation needs.

Focusing on the Perkins common platform theme, changes to engine envelope dimensions and connection points have been kept to a minimum, making for easy installation across the ratings.

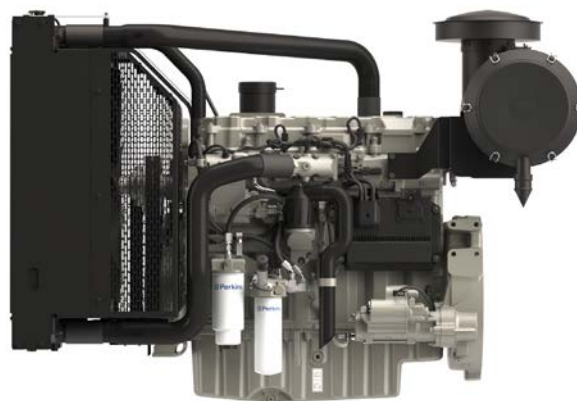

Specification		
Number of cylinders	6 vertical in-line	
Bore and stroke	112 x 149 mm	4.5 x 5.8 in
Displacement	8.8 litres	537 cubic in ³
Aspiration	Turbocharged aftercooled	
Cycle	4 stroke	
Combustion system	Direct injection	
Compression ratio	16.1:1	
Rotation	Anti-clockwise, viewed on flywheel	
Total lubricating capacity	41 litres	9.01 US gal
Cooling system	Liquid	

www.perkins.com

Photographs are for illustrative purposes only and may not reflect final specification. All information in this document is substantially correct at time of printing and may be altered subsequently. Final weight and dimensions will depend on completed specification.

Publication No. PN3090A/04/15 Produced in England ©2015 Perkins Engines Company Limited

 **Perkins®**

THE HEART OF EVERY GREAT MACHINE

1500 Series 1506A-E88TAG5 ElectropaK

293 kWm standby net power @ 1500 rpm

Features and benefits

Dependable power

- The 1506A-E88TAG5 delivers greater productivity through an improved power to weight ratio
- The world-class power density has been achieved from an 8.8 litre turbocharged engine using a hydraulic actuated unit injection (HEUI) fuel system; making this engine robust for all markets due to its ability to cope with the variation of fuel quality around the world
- In its class, the 1506A-E88TAG5 has been designed to provide dependable power even in extreme ambient climates

Low operating costs

- Oil change service intervals are set at 500 hours as standard
- Designed to provide low cost of ownership, simple maintenance and reduced downtime
- 12 months unlimited warranty with 24 months on Major items. For low use applications <500 hours per year warranty is extended by a further 12 months. See Perkins Warranty Policy for further details
- Extended Service Contracts – protect and plan the cost of ownership
Go to www.perkins.com/esc for more information

Flexibility

- The 1506-E88TAG5 has been designed to hit the power node requirements of our customers
- Switchability functionality from 50 Hz/1500 rpm to 60 Hz/1800 rpm and vice versa is available to provide greater flexibility for frequency selection

World class product support

- Our experienced global network of distributors and dealers, fully trained engine experts deliver total service support around the clock, 365 days a year. They have a comprehensive suite of web based tools at their disposal, covering technical information, parts identification and ordering systems, all dedicated to maximising the productivity of your engine
- Perkins actively pursues product support excellence by insisting our distribution network invest in their territory to provide customers with a consistent quality of support across the globe
- Throughout the entire life of a Perkins engine, we provide access to genuine OE specification parts giving 100% reassurance that you receive the very best in terms of quality for lowest possible cost, wherever your Perkins powered machine is operating in the world
- To find your local distributor: www.perkins.com/distributor

www.perkins.com

Photographs are for illustrative purposes only and may not reflect final specification.
All information in this document is substantially correct at time of printing and may be altered subsequently.
Final weight and dimensions will depend on completed specification.

Publication No. PN3090A/04/15 Produced in England ©2015 Perkins Engines Company Limited

 **Perkins**[®]

THE HEART OF EVERY GREAT MACHINE

1500 Series 1506A-E88TAG5 Electropak

293 kWm standby net power @ 1500 rpm

Technical information

Air inlet system

- Mounted air filter and turbocharger

Fuel system

- HEUI fuel system with full authority electronic control
- Electronic governing to ISO 8528-5 with stand-alone isochronous and load-sharing capabilities
- Fuel filter, fuel transfer pump, fuel priming pump
- Spin on primary, secondary and water filter separator

Lubrication system

- Wet full aluminium sump with filler and dipstick
- Full-flow spin-on filters
- Oil pump, gear driven

Cooling system

- Thermostatically controlled with belt driven, circulating pump and belt-drive fan
- Mounted belt driven pusher fan
- Radiator supplied loose with all guards and pipes
- Air-to-air charge cooler incorporated in radiator

Electrical equipment

- 24V starter motor and 24V, 45 amp alternator with DC output
- Electronic Control Module (ECM) mounted on engine with wiring looms and sensors

Flywheel and housing

- High inertia flywheel to SAE 1 J620 Size 355.6 mm (14 in)
- Aluminium SAE 1 flywheel housing

Mountings

- Front engine mounting bracket

www.perkins.com

Photographs are for illustrative purposes only and may not reflect final specification.
All information in this document is substantially correct at time of printing and may be altered subsequently.
Final weight and dimensions will depend on completed specification.

Publication No. PN3090A/04/15 Produced in England ©2015 Perkins Engines Company Limited

 **Perkins**[®]

THE HEART OF EVERY GREAT MACHINE

1500 Series 1506A-E88TAG5 Electropak

293 kWm standby net power @ 1500 rpm

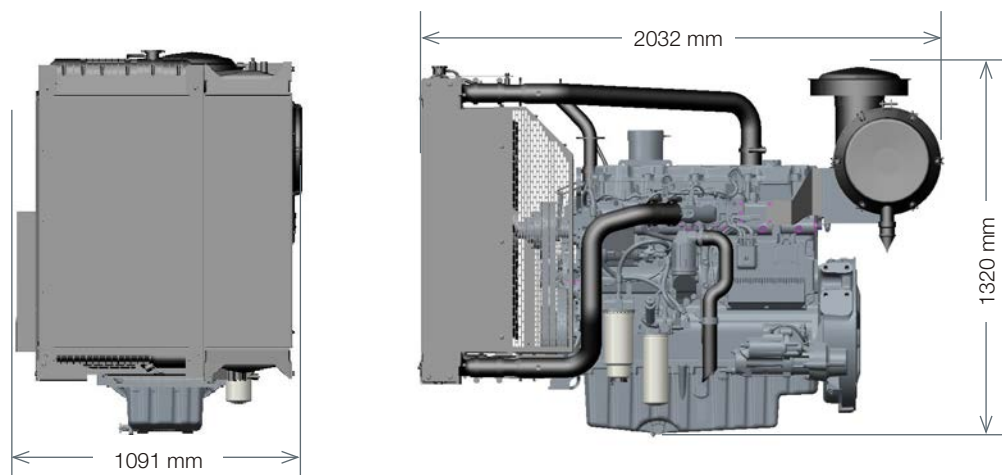

Engine package weights and dimensions

Length (including air cleaner)	2032 mm	80 in
Width	1091 mm	43 in
Height	1320 mm	52 in
Weight (dry)	1183 kg	2608 lb

www.perkins.com

Photographs are for illustrative purposes only and may not reflect final specification.
All information in this document is substantially correct at time of printing and may be altered subsequently.
Final weight and dimensions will depend on completed specification.

Publication No. PN3090A/04/15 Produced in England ©2015 Perkins Engines Company Limited

 **Perkins**[®]

THE HEART OF EVERY GREAT MACHINE

1500 Series 1506A-E88TAG5 ElectropaK

293 kWm standby net power @ 1500 rpm

Speed rpm	Type of operation	Typical generator output		Engine power (Net)	
		kVA	kWe	kWm	hp
1500	Prime power	300	240	267	358
	Standby power	330	264	293	393

Percent of prime power	Fuel consumption at 1500 rpm g/kWh	Fuel consumption at 1500 rpm l/hr
Standby power	202	73
Prime power	196	65
75%	195	48
50%	198	33

www.perkins.com

Photographs are for illustrative purposes only and may not reflect final specification.
All information in this document is substantially correct at time of printing and may be altered subsequently.
Final weight and dimensions will depend on completed specification.

Publication No. PN3090A/04/15 Produced in England ©2015 Perkins Engines Company Limited

 **Perkins**[®]

THE HEART OF EVERY GREAT MACHINE



GENERATOR TYPE ECO 38-3LN/4

Document : DS075A/1

issue 004 date 28/10/2013

Electrical Characteristics										
Frequency	Hz	50				60				
Voltage (series star)	V	380	400	415	440	415	440	460	480	
Rated power class H	kVA	350	350	350	340	380	420	420	420	
	kW	280	280	280	272	304	336	336	336	
Rated power class F	kVA	320	320	320	310	350	385	385	385	
	kW	256	256	256	248	280	308	308	308	
Regulation with DSR		±1 % with any power factor and speed variations between -5% +30%								
Insulation class		H								
Execution		Brushless								
Stator winding		12 ends								
Rotor		with damping cage								
Efficiencies class H	4/4	%	93,4	93,5	93,2	93	93,6	94,1	94,2	94,3
(see graph. for details)	3/4	%	93,4	93,7	93,6	93,3	93,9	94,1	94,3	94,5
	2/4	%	92,5	92,6	92,6	92,4	93	93,1	93,2	93,3
	1/4	%	90,1	89,9	89,7	89,5	90,6	90,6	90,6	90,4
Reactances (f. l.cl. F)	Xd	%	238,2	215	199,7	172,6	260,2	255,9	234,1	215
	Xd'	%	19,1	17,2	16,0	13,8	20,8	20,5	18,7	17,2
	Xd''	%	10,4	9,4	8,7	7,5	11,4	11,2	10,2	9,4
	Xq	%	139,6	126	117,1	101,2	152,5	150,0	137,2	126
	Xq'	%	139,6	126	117,1	101,2	152,5	150,0	137,2	126
	Xq''	%	22,3	20,1	18,7	16,1	24,3	23,9	21,9	20,1
	X ₂	%	17,4	15,7	14,6	12,6	19,0	18,7	17,1	15,7
	X ₀	%	2,4	2,2	2,0	1,8	2,7	2,6	2,4	2,2
Short Circuit Ratio	Kcc		0,37	0,42	0,57	0,92	0,24	0,32	0,37	0,42
Time Constants	Td'	sec.	0,099							
	Td''	sec.	0,0127							
	Tdo'	sec.	1,50							
	Tα	sec.	0,013							
Short Circuit Current Capacity		%	>300				>350			
Excitation at no load	Amp.		0,55	0,72	0,95	1,2	0,35	0,35	0,6	0,7
Excitation at full load	Amp.		3,5	3,9	4,1	4,3	3,3	3,5	3,7	3,9
Overload (long-term)		%	1 hour in a 6 hours period 110% rated load							
Overload per 20 sec.		%	300							
Stator Winding Resistance (20 °C)		Ω	0,0042							
Rotor Winding Resistance (20 °C)		Ω	6,780							
Exciter Resistance (20 °C)		Ω	Rotor : 0,685				Stator : 15,28			
Heat dissipation at f.l.cl.H	W		19786	19465	20429	20473	20786	21067	20688	20310
Telephone Interference			THF < 2%				TIF < 40			
Radio interference			EN61000-6-3, EN61000-6-2. For others standards apply to factory							
Waveform Distors.(THD) at f. load	LL/LN %		3,1 / 2,9							
Waveform Distors.(THD) at no load	LL/LN %		2,7 / 2,7							
Mechanical characteristics										
Protection			IP 21 (other protection on request)							
DE bearing			6318.2RS							
NDE bearing			6314.2RS							
Weight of wound stator assembly	kg		347							
Weight of wound rotor assembly	kg		230							
Weight of complete generator	kg		905							
Maximun overspeed	rpm		2250							
Unbalanced magnetic pull at f.l.cl.F	kN/mm		6,2							
Cooling air requirement	m ³ /min		32				39			
Inertia Constant (H)	sec.		0,123				0,147			
Noise level at 1m/7m	dB(A)		82 / 69				86 / 73			

All technical data are to be considered as a reference and they can be modified without any notice.

This document is a propriety of Mecc Alte S.p.a..All rights reserved.



GENERATOR TYPE ECO 38-3LN/4

Document : DS075A/2

issue 004 date : 28/10/2013

50 Hz

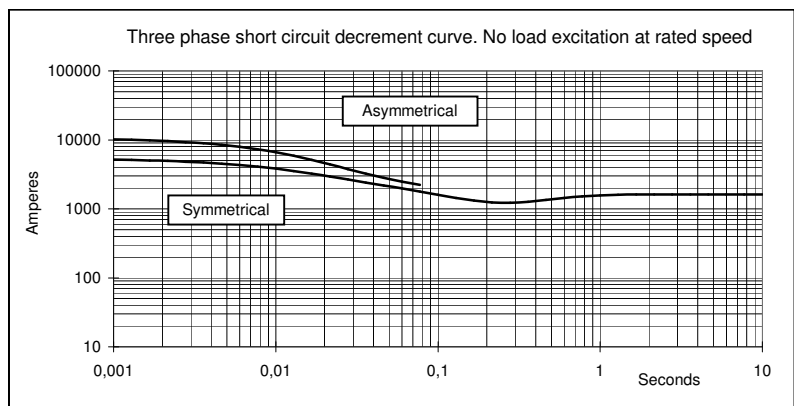
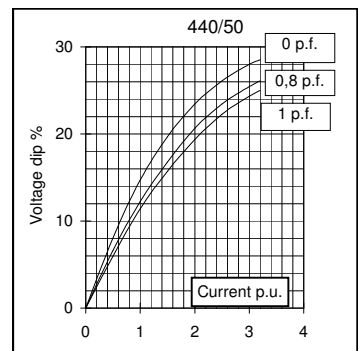
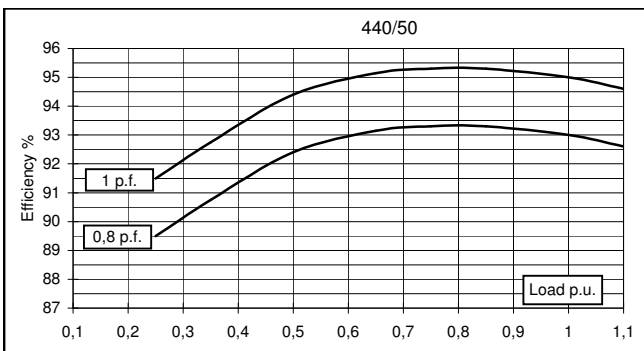
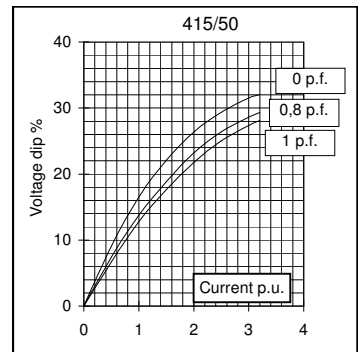
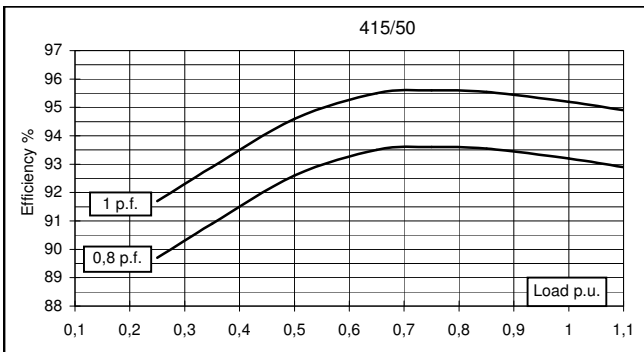
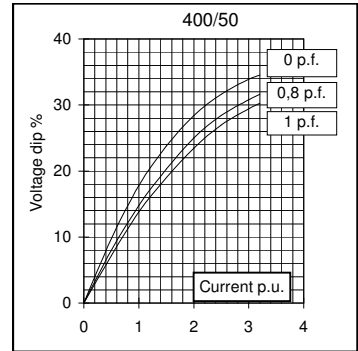
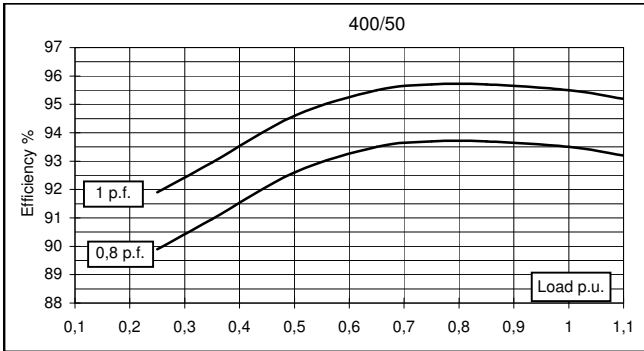
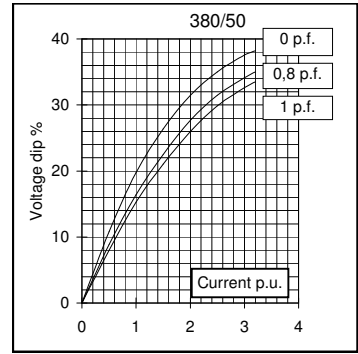
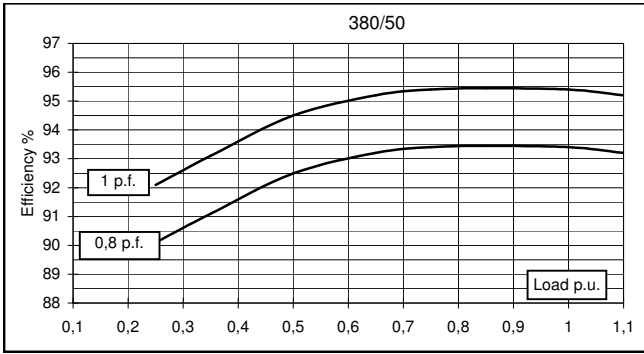



GENERATOR TYPE ECO 38-3LN/4

Document : DS075A/3

issue 004 date : 28/10/2013

60 Hz

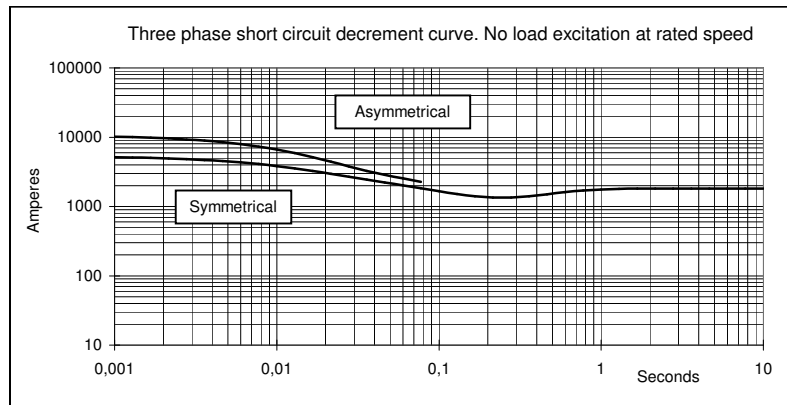
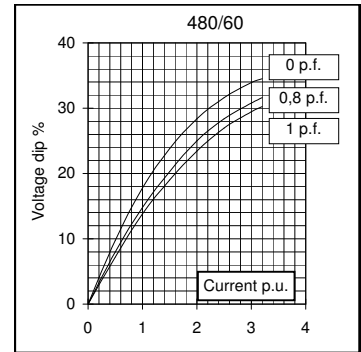
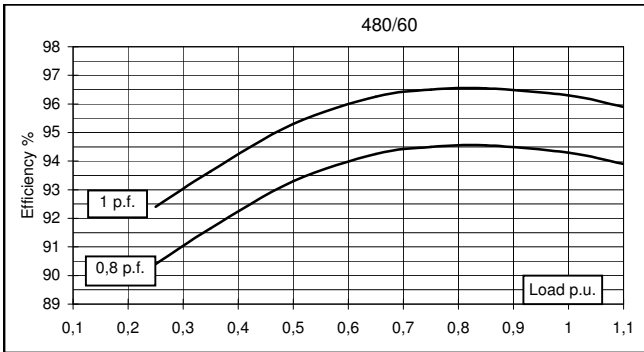
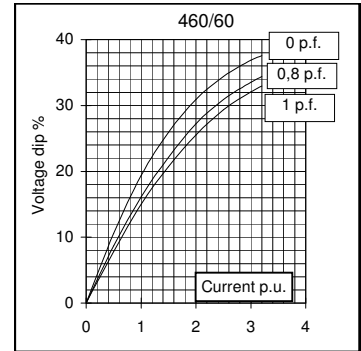
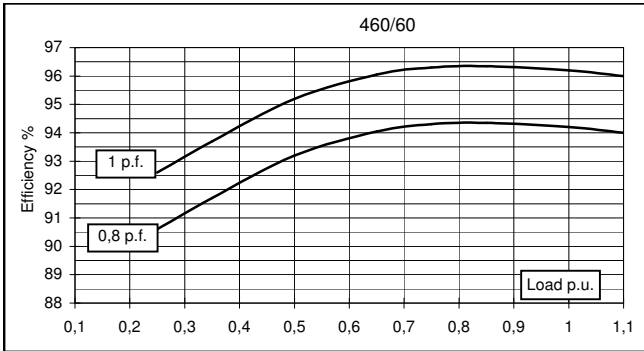
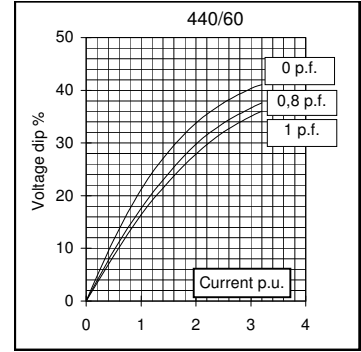
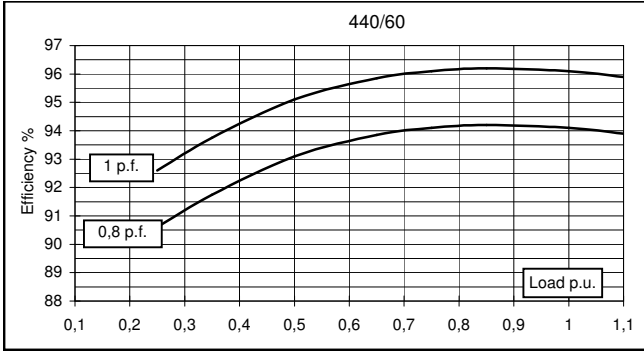
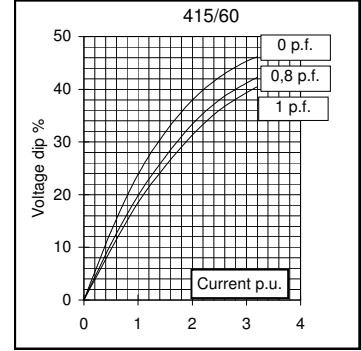
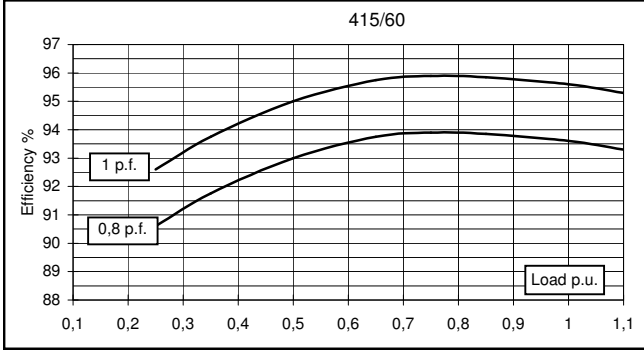

TWO BEARING MOMENTS OF INERTIA

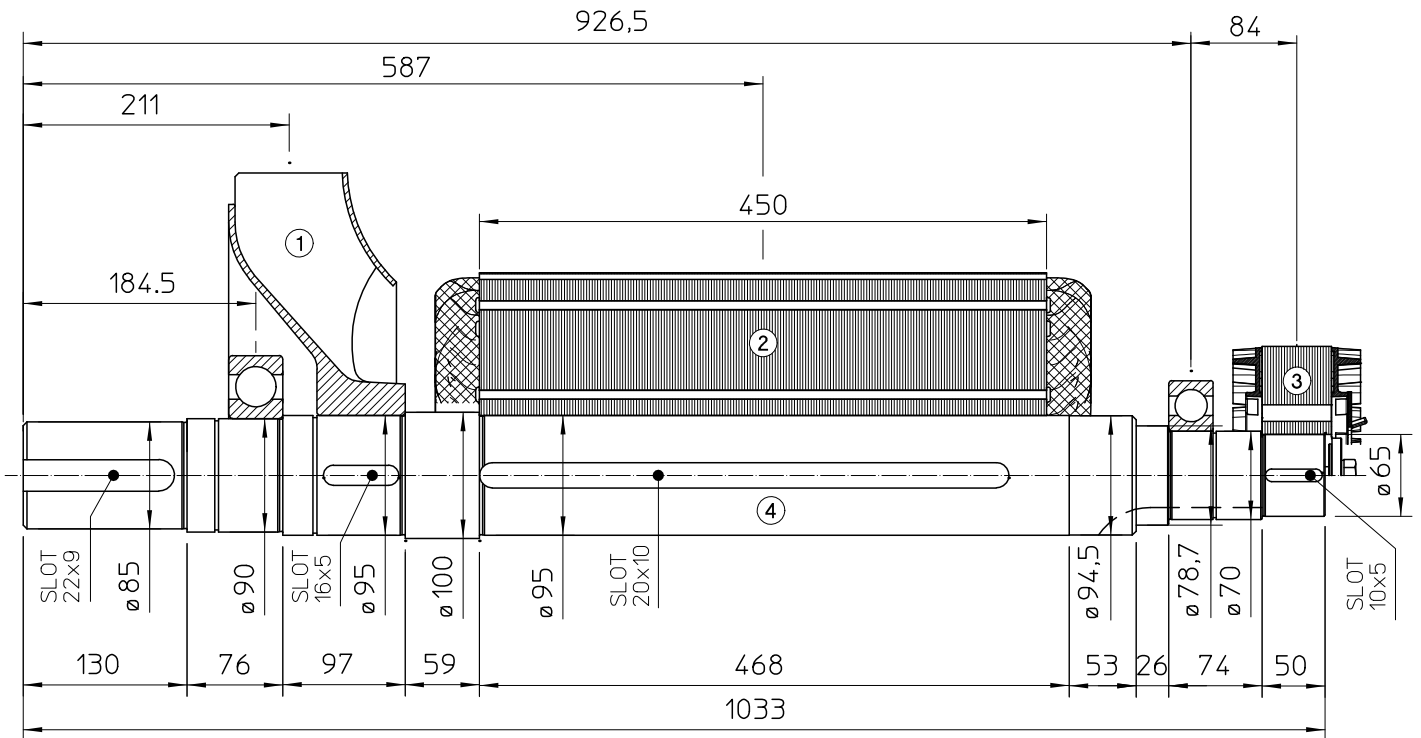

POS.	COMPONENT	WEIGHT (kg)	J (kgm ²)
1	FAN	6.1	0.1887
2	MAIN ROTOR	230	3.1461
3	EX. ROTOR	14.5	0.0874
4	SHAFT	49.9	0.0525
TOTAL		300.5	3.4747

TWO BEARING DIMENSIONS

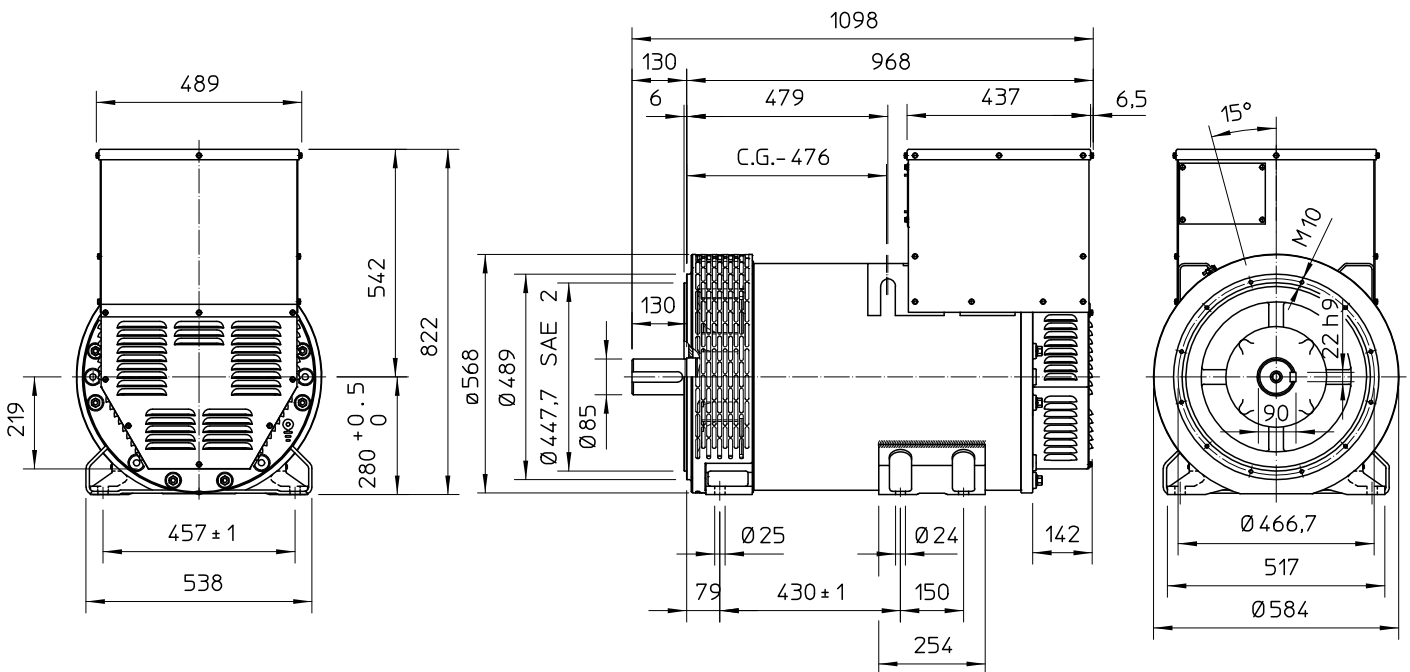

C.G.= GRAVITY CENTER

SINGLE BEARING MOMENTS OF INERTIA

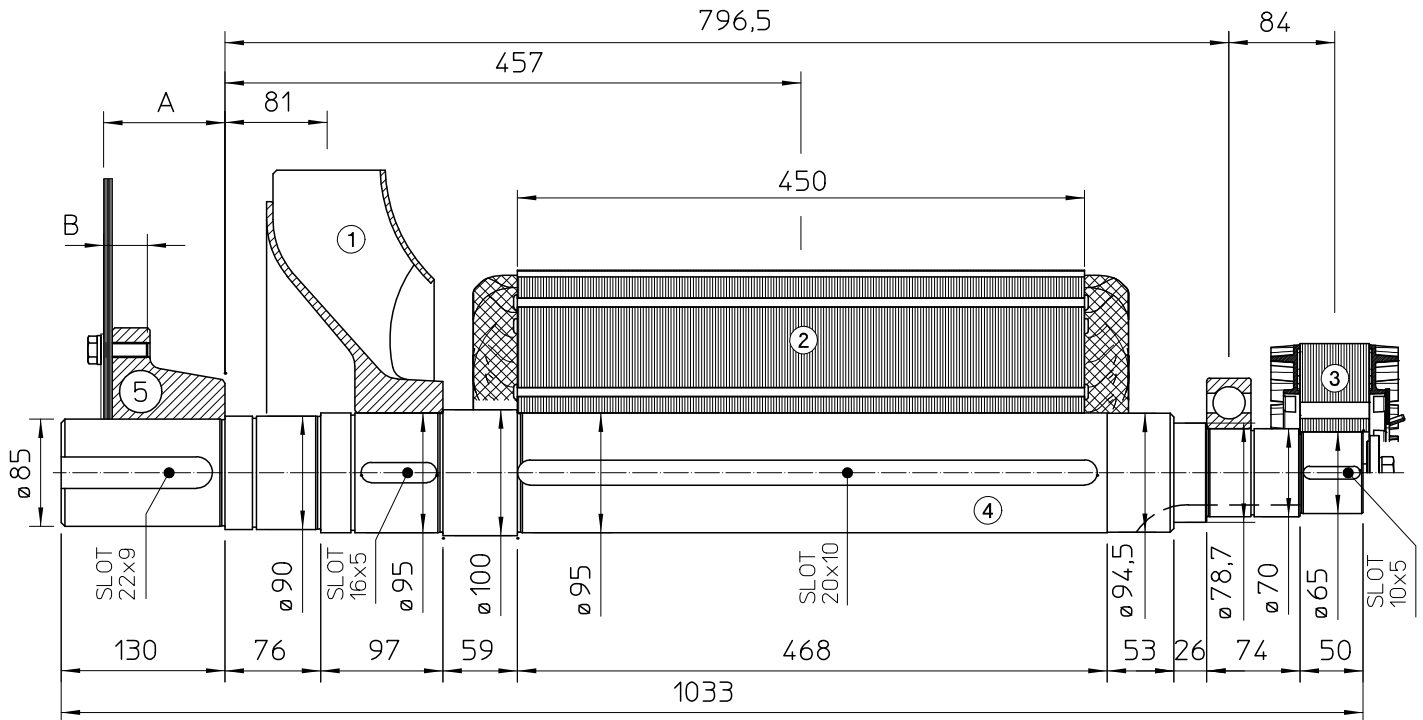

POS.	COMPONENT	WEIGHT (kg)	J (kgm ²)
1	FAN	6.1	0.1887
2	MAIN ROTOR	230	3.1461
3	EX. ROTOR	14.5	0.0874
4	SHAFT	49.9	0.0525
TOTAL		300.5	3.4747

SAE N°	5		SHAFTS COUPLING FLEX PLATE	
	A	B	WEIGHT kg	J kgm ²
11.5	110.4	41.1	20.5	0.174
14	96.4	34.7	23.5	0.275

SINGLE BEARING DIMENSIONS

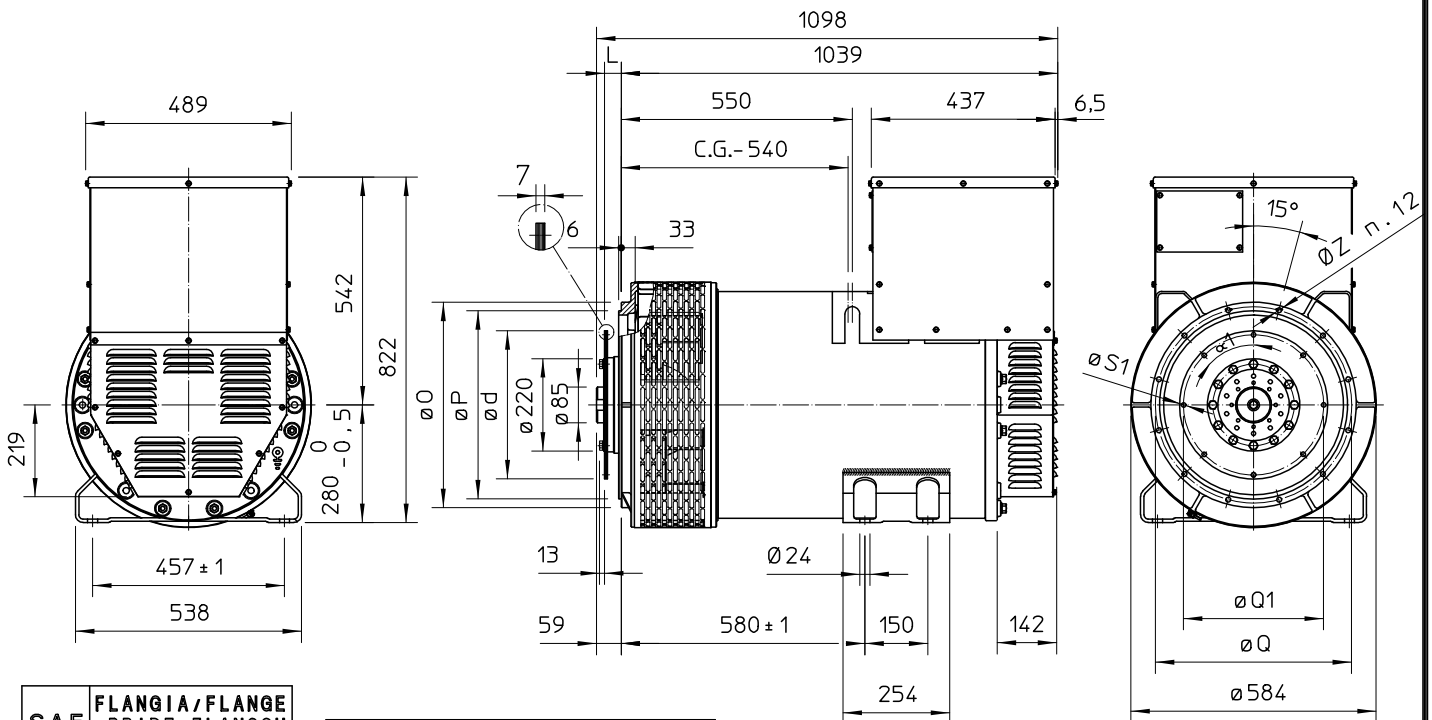

SAE N.	FLANGIA/FLANGE BRIDE/FLANSCH		
	O	P	Q
3	451	409,6	428,6
2	489	447,7	466,7
1	552	511,2	530,2
1/2	648	584,2	619,1

SAE N.	GIUNTI A DISCHI DISC COUPLING DISQUE DE MONOPALIER SCHEIBENKUPPLUNG					
	L	d	Q1	n _{fori}	S1	α1
11 1/2	39,6	352,42	333,37	8	11	45°
14	25,4	466,72	438,15	8	14	45°

C.G.= GRAVITY CENTER

STAMFORD®

HCI 434D/444D - Technical Data Sheet

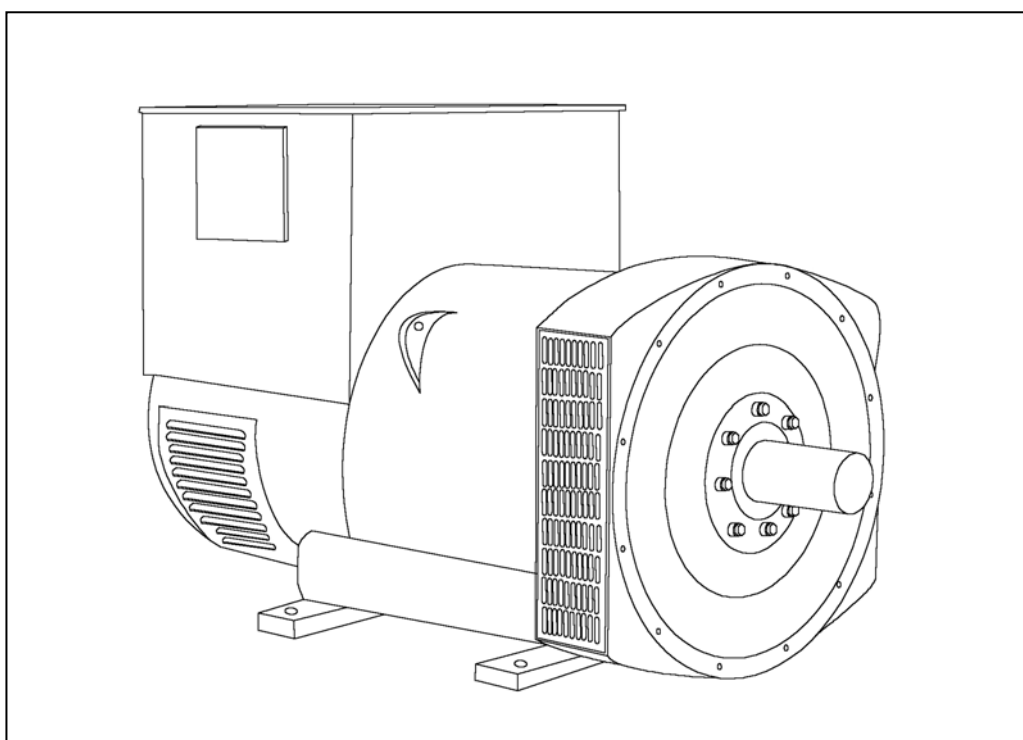

HCI434D/444D

SPECIFICATIONS & OPTIONS

STAMFORD

STANDARDS

Newage Stamford industrial generators meet the requirements of BS EN 60034 and the relevant section of other international standards such as BS5000, VDE 0530, NEMA MG1-32, IEC34, CSA C22.2-100, AS1359. Other standards and certifications can be considered on request.

VOLTAGE REGULATORS

AS440 AVR - STANDARD

With this self-excited system the main stator provides power via the Automatic Voltage Regulator (AVR) to the exciter stator. The high efficiency semi-conductors of the AVR ensure positive build-up from initial low levels of residual voltage.

The exciter rotor output is fed to the main rotor through a three-phase full-wave bridge rectifier. The rectifier is protected by a surge suppressor against surges caused, for example, by short circuit or out-of-phase paralleling.

The AS440 will support a range of electronic accessories, including a 'droop' Current Transformer (CT) to permit parallel operation with other ac generators.

MX341 AVR

This sophisticated AVR is incorporated into the Stamford Permanent Magnet Generator (PMG) control system.

The PMG provides power via the AVR to the main exciter, giving a source of constant excitation power independent of generator output. The main exciter output is then fed to the main rotor, through a full wave bridge, protected by a surge suppressor. The AVR has in-built protection against sustained over-excitation, caused by internal or external faults. This de-excites the machine after a minimum of 5 seconds.

An engine relief load acceptance feature can enable full load to be applied to the generator in a single step.

If three-phase sensing is required with the PMG system the MX321 AVR must be used.

We recommend three-phase sensing for applications with greatly unbalanced or highly non-linear loads.

MX321 AVR

The most sophisticated of all our AVRs combines all the features of the MX341 with, additionally, three-phase rms sensing, for improved regulation and performance.

Over voltage protection is built-in and short circuit current level adjustments is an optional facility.

WINDINGS & ELECTRICAL PERFORMANCE

All generator stators are wound to 2/3 pitch. This eliminates triplen (3rd, 9th, 15th ...) harmonics on the voltage waveform and is found to be the optimum design for trouble-free supply of non-linear loads. The 2/3 pitch design avoids excessive neutral currents sometimes seen with higher winding pitches, when in parallel with the mains. A fully connected damper winding reduces oscillations during paralleling. This winding, with the 2/3 pitch and carefully selected pole and tooth designs, ensures very low waveform distortion.

TERMINALS & TERMINAL BOX

Standard generators are 3-phase reconnectable with 12 ends brought out to the terminals, which are mounted on a cover at the non-drive end of the generator. A sheet steel terminal box contains the AVR and provides ample space for the customers' wiring and gland arrangements. It has removable panels for easy access.

SHAFT & KEYS

All generator rotors are dynamically balanced to better than BS6861:Part 1 Grade 2.5 for minimum vibration in operation. Two bearing generators are balanced with a half key.

INSULATION/IMPREGNATION

The insulation system is class 'H'.

All wound components are impregnated with materials and processes designed specifically to provide the high build required for static windings and the high mechanical strength required for rotating components.

QUALITY ASSURANCE

Generators are manufactured using production procedures having a quality assurance level to BS EN ISO 9001.

The stated voltage regulation may not be maintained in the presence of certain radio transmitted signals. Any change in performance will fall within the limits of Criteria 'B' of EN 61000-6-2:2001. At no time will the steady-state voltage regulation exceed 2%.

NB Continuous development of our products entitles us to change specification details without notice, therefore they must not be regarded as binding.

Front cover drawing typical of product range.

HCI434D/444D



WINDING 311

CONTROL SYSTEM	SEPARATELY EXCITED BY P.M.G.							
A.V.R.	MX321	MX341						
VOLTAGE REGULATION	± 0.5 %	± 1.0 %	With 4% ENGINE GOVERNING					
SUSTAINED SHORT CIRCUIT	REFER TO SHORT CIRCUIT DECREMENT CURVES (page 7)							
CONTROL SYSTEM	SELF EXCITED							
A.V.R.	AS440							
VOLTAGE REGULATION	± 1.0 %	With 4% ENGINE GOVERNING						
SUSTAINED SHORT CIRCUIT	WILL NOT SUSTAIN A SHORT CIRCUIT							
INSULATION SYSTEM	CLASS H							
PROTECTION	IP23							
RATED POWER FACTOR	0.8							
STATOR WINDING	DOUBLE LAYER LAP							
WINDING PITCH	TWO THIRDS							
WINDING LEADS	12							
STATOR WDG. RESISTANCE	0.0124 Ohms PER PHASE AT 22°C SERIES STAR CONNECTED							
ROTOR WDG. RESISTANCE	1.05 Ohms at 22°C							
EXCITER STATOR RESISTANCE	18 Ohms at 22°C							
EXCITER ROTOR RESISTANCE	0.068 Ohms PER PHASE AT 22°C							
R.F.I. SUPPRESSION	BS EN 61000-6-2 & BS EN 61000-6-4, VDE 0875G, VDE 0875N. refer to factory for others							
WAVEFORM DISTORTION	NO LOAD < 1.5% NON-DISTORTING BALANCED LINEAR LOAD < 5.0%							
MAXIMUM OVERSPEED	2250 Rev/Min							
BEARING DRIVE END	BALL. 6317 (ISO)							
BEARING NON-DRIVE END	BALL. 6314 (ISO)							
	1 BEARING				2 BEARING			
WEIGHT COMP. GENERATOR	940 kg				950 kg			
WEIGHT WOUND STATOR	415 kg				415 kg			
WEIGHT WOUND ROTOR	361 kg				338 kg			
WR ² INERTIA	4.0771 kgm ²				3.8783 kgm ²			
SHIPPING WEIGHTS in a crate	1010 kg				1010 kg			
PACKING CRATE SIZE	155 x 87 x 107(cm)				155 x 87 x 107(cm)			
	50 Hz				60 Hz			
TELEPHONE INTERFERENCE	THF<2%				TIF<50			
COOLING AIR	0.8 m ³ /sec 1700 cfm				0.99 m ³ /sec 2100 cfm			
VOLTAGE SERIES STAR	380/220	400/231	415/240	440/254	416/240	440/254	460/266	480/277
VOLTAGE PARALLEL STAR	190/110	200/115	208/120	220/127	208/120	220/127	230/133	240/138
VOLTAGE SERIES DELTA	220/110	230/115	240/120	254/127	240/120	254/127	266/133	277/138
KVA BASE RATING FOR REACTANCE VALUES	300	300	300	290	340	360	375	375
X _d DIR. AXIS SYNCHRONOUS	3.16	2.85	2.65	2.28	3.56	3.37	3.21	2.95
X' _d DIR. AXIS TRANSIENT	0.20	0.18	0.17	0.15	0.22	0.21	0.20	0.18
X'' _d DIR. AXIS SUBTRANSIENT	0.14	0.13	0.12	0.10	0.15	0.14	0.14	0.12
X _q QUAD. AXIS REACTANCE	2.66	2.40	2.23	1.92	3.05	2.89	2.75	2.53
X'' _q QUAD. AXIS SUBTRANSIENT	0.39	0.36	0.33	0.28	0.40	0.38	0.36	0.33
X _L LEAKAGE REACTANCE	0.07	0.06	0.06	0.05	0.09	0.09	0.08	0.07
X ₂ NEGATIVE SEQUENCE	0.26	0.24	0.22	0.19	0.28	0.27	0.25	0.23
X ₀ ZERO SEQUENCE	0.10	0.09	0.08	0.07	0.10	0.09	0.09	0.08
REACTANCES ARE SATURATED				VALUES ARE PER UNIT AT RATING AND VOLTAGE INDICATED				
T' _d TRANSIENT TIME CONST.	0.08s							
T'' _d SUB-TRANSTIME CONST.	0.019s							
T' _{do} O.C. FIELD TIME CONST.	1.7s							
T _a ARMATURE TIME CONST.	0.018s							
SHORT CIRCUIT RATIO	1/X _d							

50
Hz

HCI434D/444D

STAMFORD

Winding 311

THREE PHASE EFFICIENCY CURVES

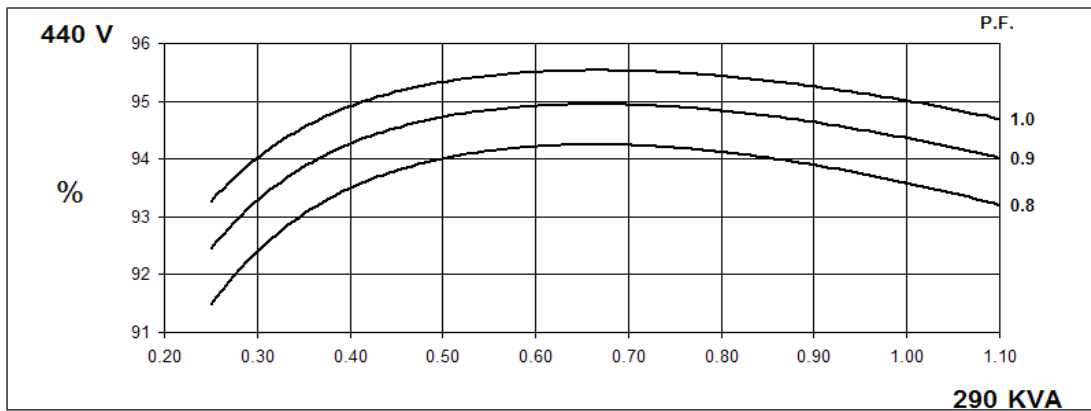
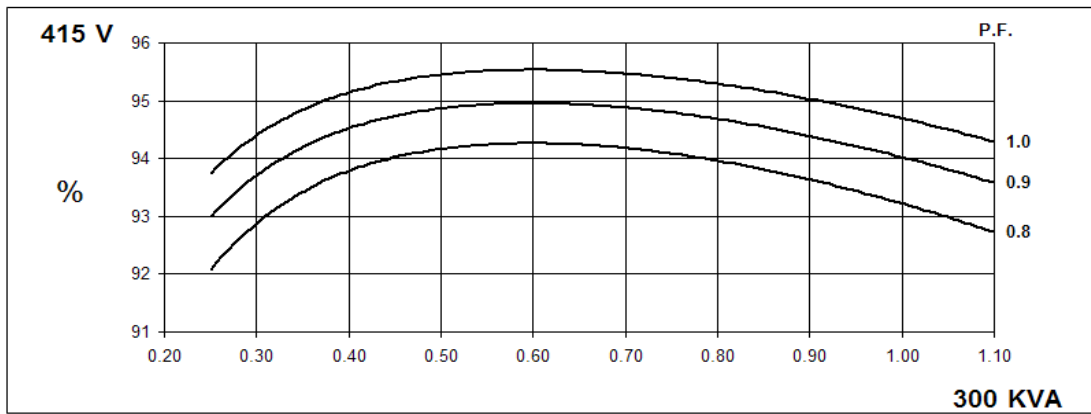
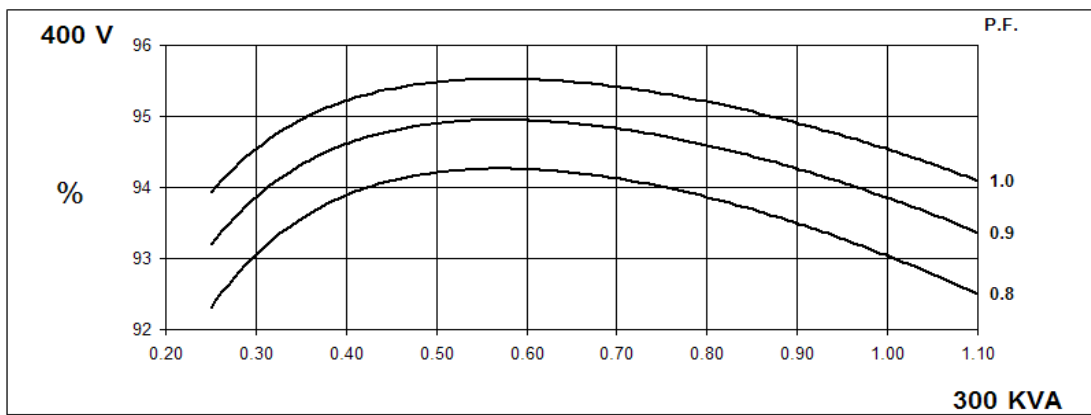
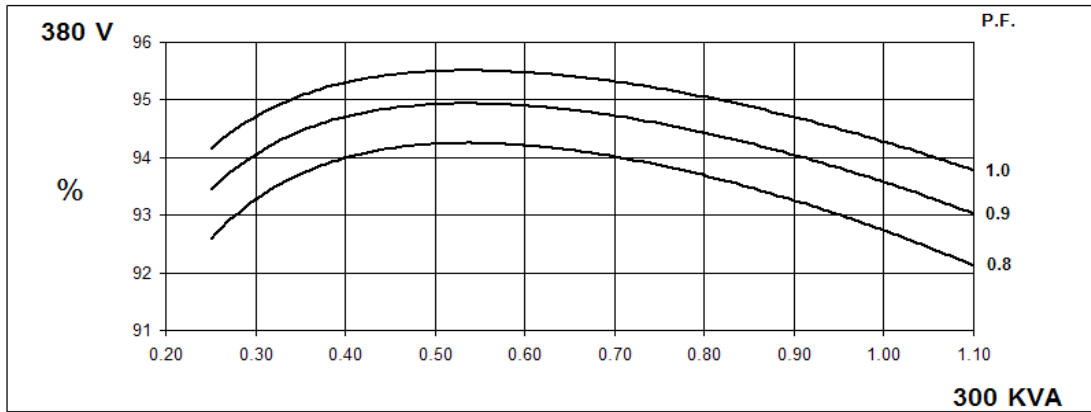

60
Hz

HCI434D/444D

STAMFORD

Winding 311

THREE PHASE EFFICIENCY CURVES

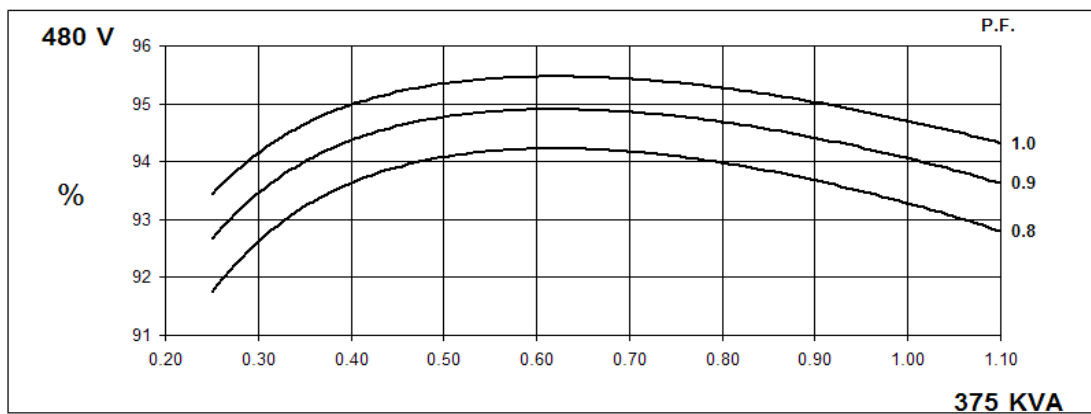
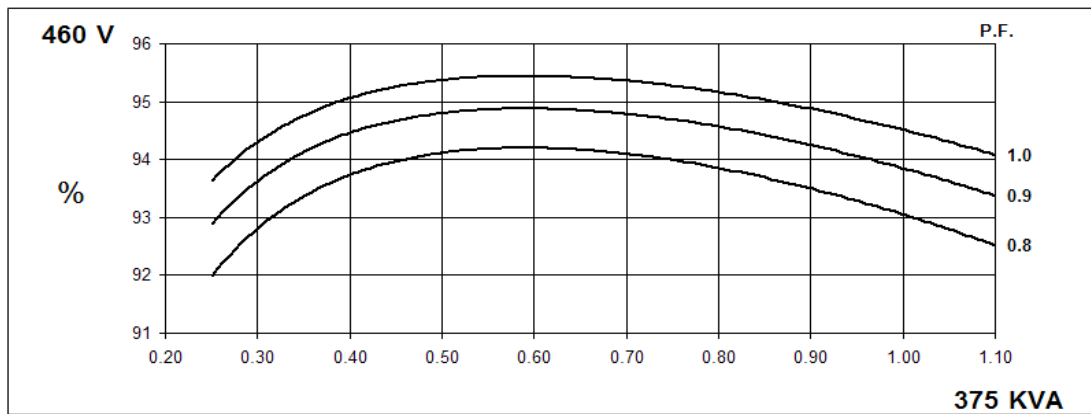
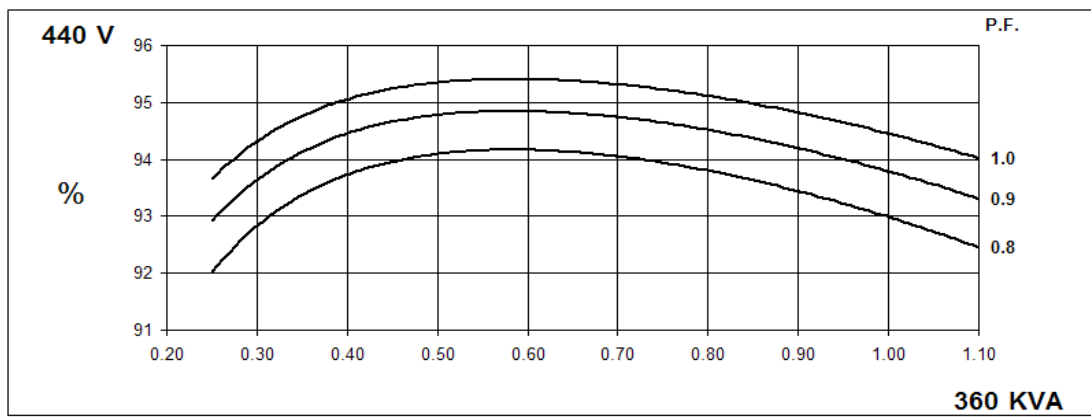
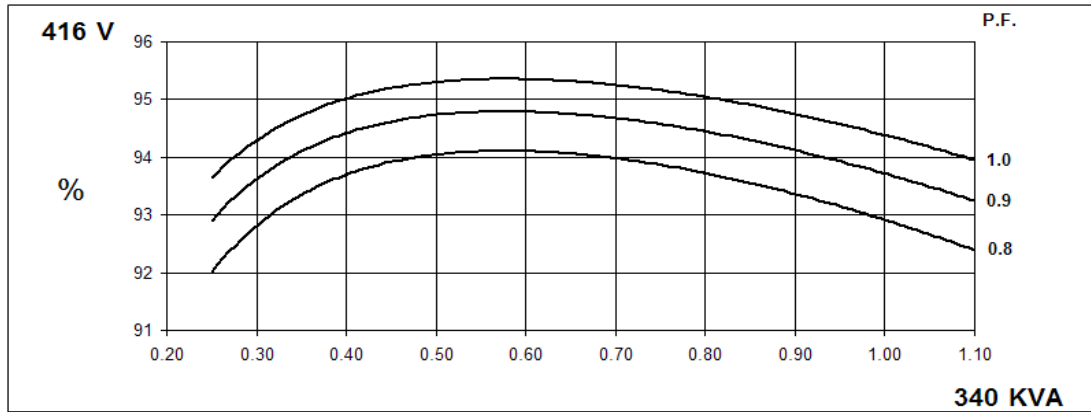

Locked Rotor Motor Starting Curve

50
Hz

MX

SX

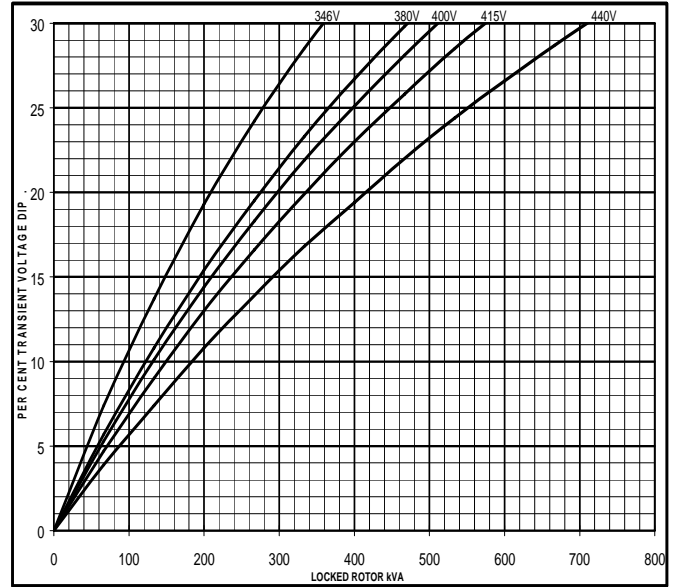
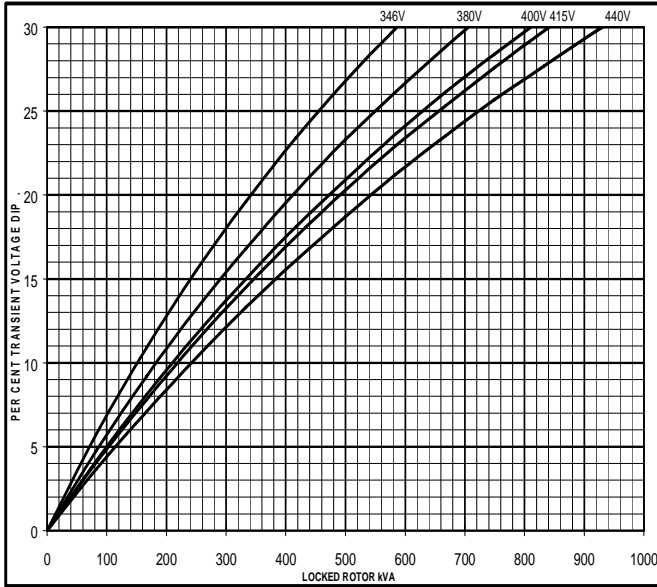

60
Hz

MX

SX

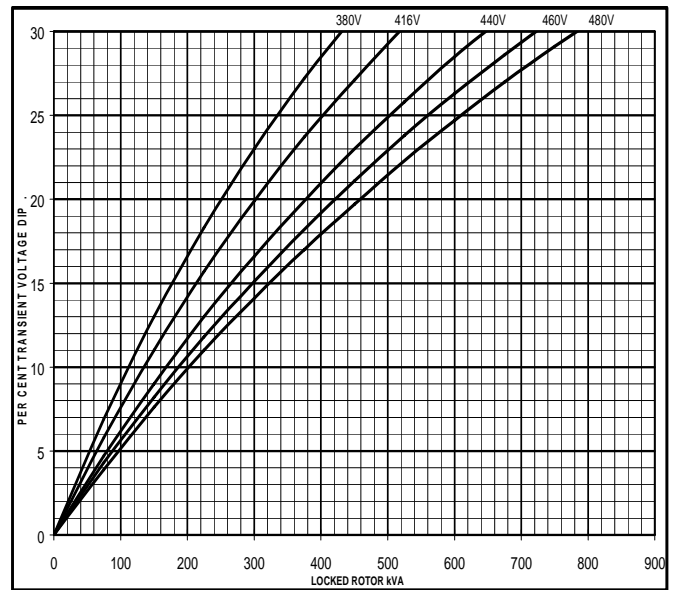
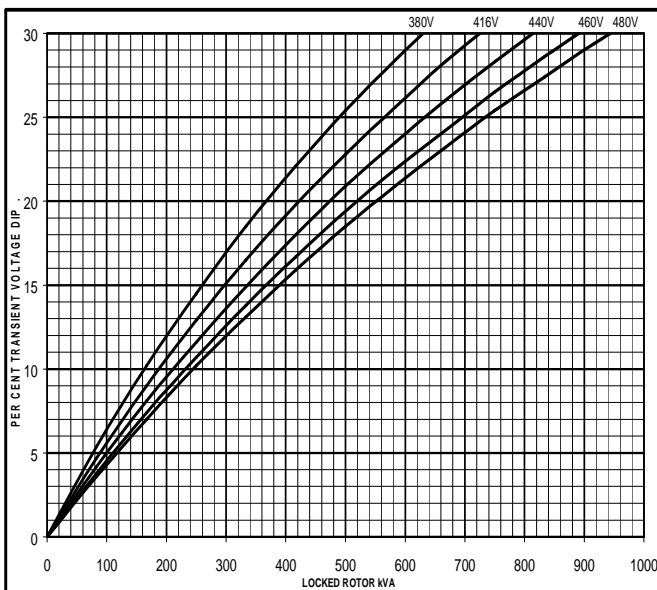

**Three-phase Short Circuit Decrement Curve. No-load Excitation at Rated Speed
Based on star (wye) connection.**

**50
Hz**

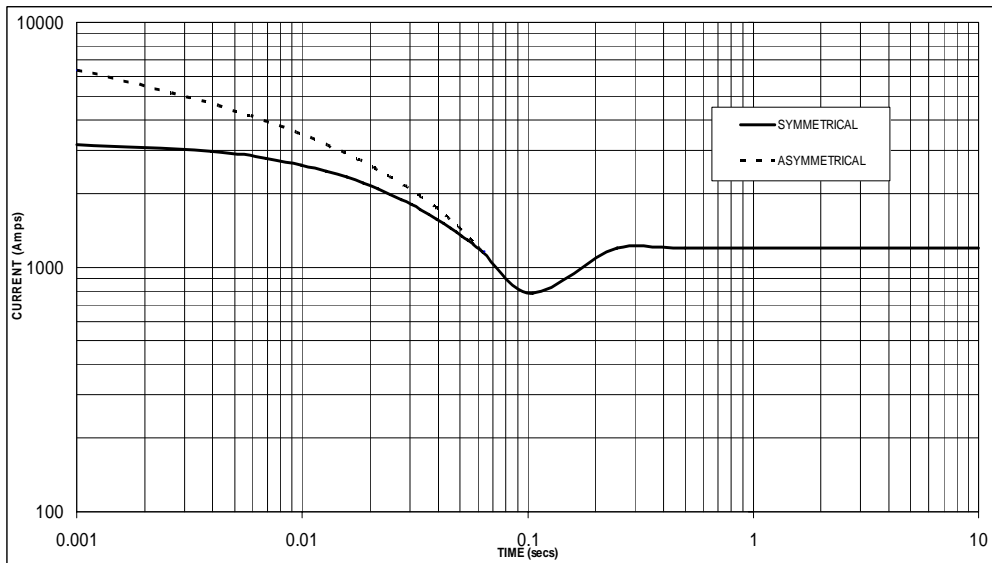

Sustained Short Circuit = 1,200 Amps

**60
Hz**

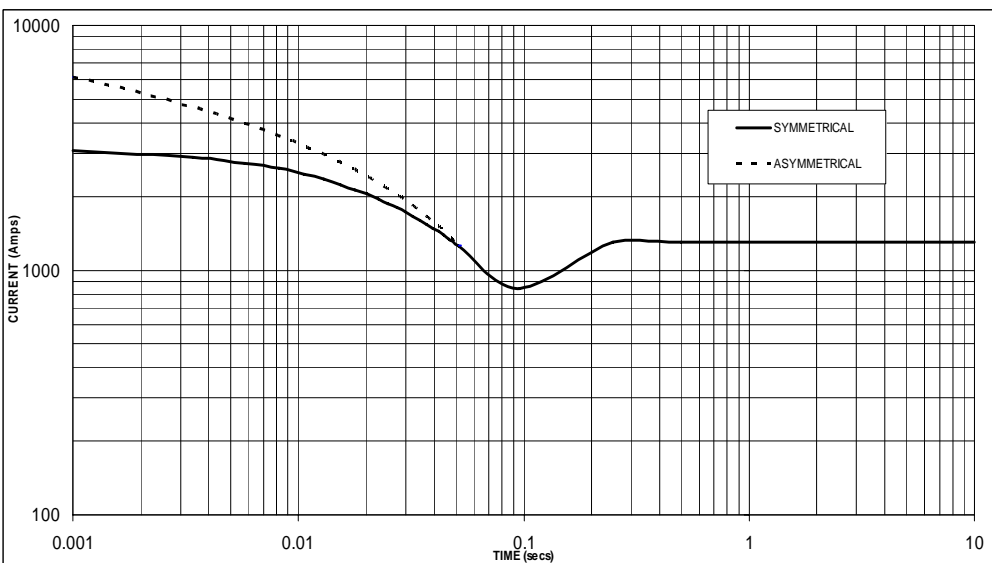

Sustained Short Circuit = 1,300 Amps

Note 1

The following multiplication factors should be used to adjust the values from curve between time 0.001 seconds and the minimum current point in respect of nominal operating voltage :

50Hz		60Hz	
Voltage	Factor	Voltage	Factor
380v	X 1.00	416v	X 1.00
400v	X 1.05	440v	X 1.06
415v	X 1.09	460v	X 1.10
440v	X 1.16	480v	X 1.15

The sustained current value is constant irrespective of voltage level

Note 2

The following multiplication factor should be used to convert the values calculated in accordance with NOTE 1 to those applicable to the various types of short circuit :

	3-phase	2-phase L-L	1-phase L-N
Instantaneous	x 1.00	x 0.87	x 1.30
Minimum	x 1.00	x 1.80	x 3.20
Sustained	x 1.00	x 1.50	x 2.50
Max. sustained duration	10 sec.	5 sec.	2 sec.

All other times are unchanged

Note 3

Curves are drawn for Star (Wye) connected machines. For other connection the following multipliers should be applied to current values as shown :

HCI434D/444D

Winding 311 / 0.8 Power Factor

STAMFORD

RATINGS

Class - Temp Rise	Cont. F - 105/40°C				Cont. H - 125/40°C				Standby - 150/40°C				Standby - 163/27°C				
50 Hz	Series Star (V)	380	400	415	440	380	400	415	440	380	400	415	440	380	400	415	440
	Parallel Star (V)	190	200	208	220	190	200	208	220	190	200	208	220	190	200	208	220
	Series Delta (V)	220	230	240	254	220	230	240	254	220	230	240	254	220	230	240	254
kVA	280	280	280	270	300	300	300	290	320	320	320	310	330	330	330	320	
kW	224	224	224	216	240	240	240	232	256	256	256	248	264	264	264	256	
Efficiency (%)	93.1	93.4	93.5	93.8	92.7	93.0	93.2	93.6	92.3	92.7	92.9	93.3	92.1	92.5	92.7	93.2	
kW Input	241	240	240	230	259	258	258	248	277	276	276	266	287	285	285	275	

60 Hz	Series Star (V)	416	440	460	480	416	440	460	480	416	440	460	480	416	440	460	480
	Parallel Star (V)	208	220	230	240	208	220	230	240	208	220	230	240	208	220	230	240
	Series Delta (V)	240	254	266	277	240	254	266	277	240	254	266	277	240	254	266	277
kVA	315	335	345	345	340	360	375	375	365	385	400	400	375	395	415	415	
kW	252	268	276	276	272	288	300	300	292	308	320	320	300	316	332	332	
Efficiency (%)	93.3	93.3	93.4	93.6	92.9	93.0	93.1	93.3	92.5	92.6	92.7	93.0	92.4	92.5	92.5	92.8	
kW Input	270	287	296	295	293	310	322	322	316	333	345	344	325	342	359	358	

DIMENSIONS

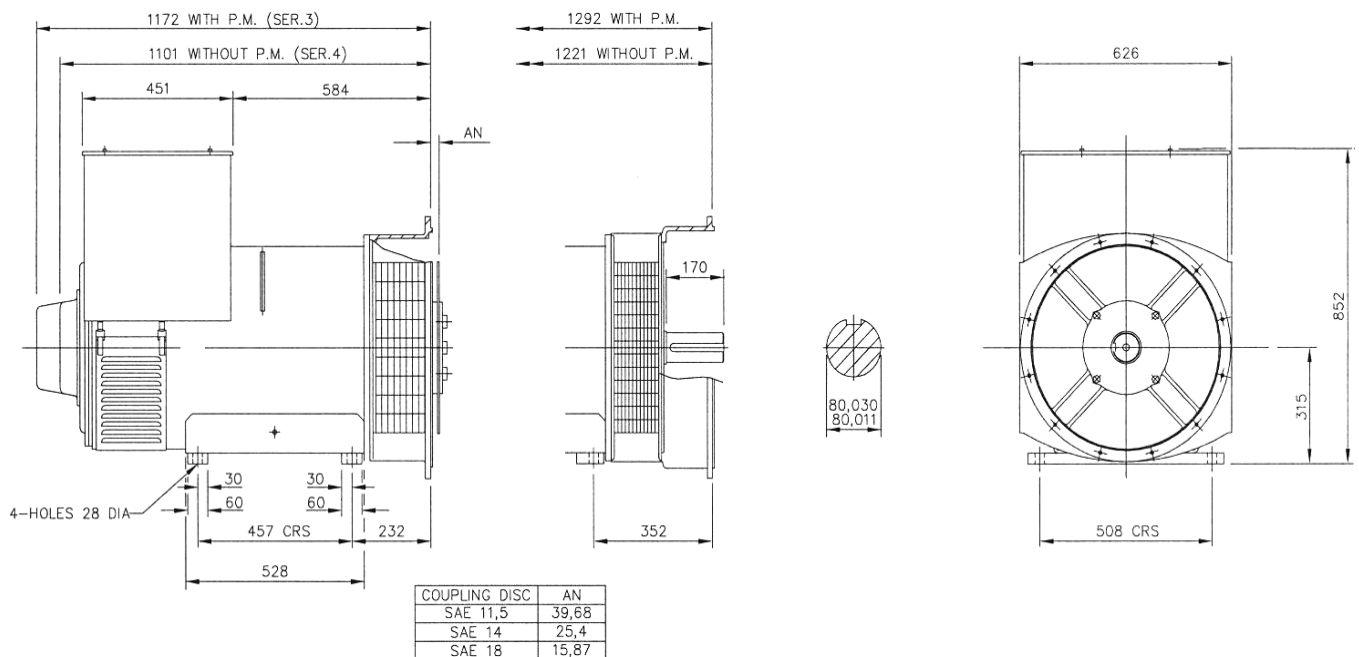

STAMFORD

Barnack Road • Stamford • Lincolnshire • PE9 2NB
Tel: 00 44 (0)1780 484000 • Fax: 00 44 (0)1780 484100